

DS-2781ZJ-X(/316L)

Explosion-Proof Terminal Box

Features

- Stainless steel 304 and stainless steel 316L (/316L) optional
- Four cable outlets
- ATEX and IECEx certified explosion-proof performance
- Ingress protection, IP68
- Power adapter preinstalled



II 2 G Ex db IIC T6 Gb

II 2 D Ex tb IIIC T80°C Db IP68

Dimension

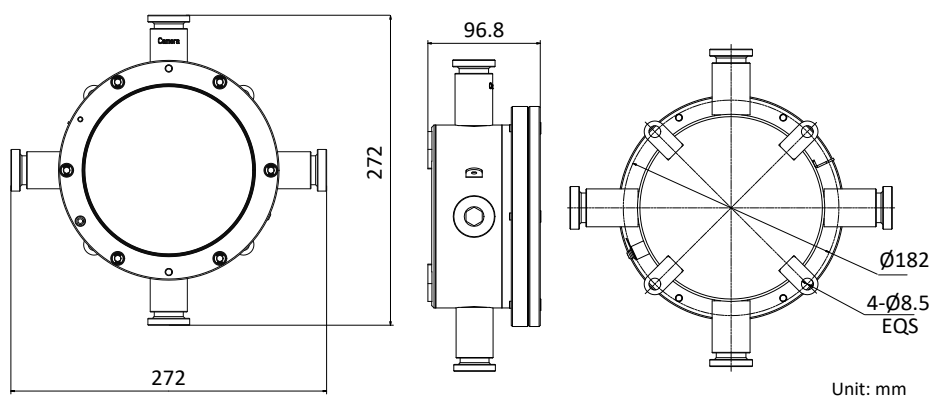

Available Model

DS-2781ZJ-X, DS-2781ZJ-X/316L

Parameter

Model	DS-2781ZJ-X, DS-2781ZJ-X/316L
Parameters	Explosion-Proof Terminal Box
Material	DS-2781ZJ-X: stainless steel 304 DS-2781ZJ-X/316L: stainless steel 316L
Dimension	272 mm × 272 mm × 96.8 mm (10.7" × 10.7" × 3.8")
Weight	Approx. 6.7 kg (14.8 lb.)
Cable Outlet	4 cable outlets, M25 × 1.5
Operating Conditions	-40°C to +60°C (-40°F to 140°F), 95%RH or less (non-condensing)
Hazardous Area	Zone 1, Zone 2, Zone 21, and Zone 22
Ingress protection	IP68
Interface	100 to 240 VAC power input, 12 VDC power output, CVBS, RS-485, 1 audio input, 1 audio output, 2 alarm inputs and 2 alarm outputs, RJ45 Ethernet interface
Power Adapter Preinstalled	Yes. Input: 100 to 240 VAC, 1.6 A (at 100 VAC input, at rated load). Output: 12 VDC, 2A
Wire Gauge	No. 22 to No. 12 AWG, max. 3.294 mm ²
Applicable Device	Device whose input voltage is 12 VDC

Note

- Read the installation guide and abide by all mentioned instructions when install the terminal box.
- Purchase certified cable glands sealed with setting compound for cable routing.
- Make sure that the installation surface is strong enough to withstand eight times the weight of the device.