

Panasonic
ideas for life

Matrix System650

MATRIX
SYSTEM
650



Matrix System 650 uses simple components to give you fully integrated control of up to 256 cameras and 32 monitors.

Matrix System 650 from Panasonic is the new, easier way to configure mid-sized to large surveillance systems. This remarkable new system makes it simple to fully integrate up to 256 cameras, 32 monitors, and 60 registered users.* Adding WJ-HD300A Series Digital Disk Recorders delivers the high image quality and high storage capacity that state-of-the-art surveillance requires.

Matrix System 650's simple, flexible architecture makes it ideal for a wide range of applications including shopping malls, multipurpose complexes, office buildings and banks. * 1 of the 60 users is reserved for recorder control.



Here is where you set Camera Title and Camera Position.

Camera

WJ-SX650 Series Administrator Console

The user-friendly GUI interface is designed to maximize usability and is available in any of 8 languages: English, French, Spanish, German, Italian, Russian, Chinese, Japanese.

Main Menu

Tips Feature Supports Set Up
To see an explanation and set-up tips, simply place the cursor over any of the buttons.

Here is where you set Timer Events and Camera Events.

Schedule

Sequence

Here is where you set Tour Sequence and Group Sequence/Group presets.

The CSV format Export/Import feature allows use of spreadsheet software to organize setup data.

The calendar supports schedule construction and review in yearly, monthly, or weekly units.

Major Features and Functions

- C a m e r a s**
- Supports up to 256 cameras (using 8 Video Input Boards).
 - All 256 channels are coaxial, multiplex cables, reducing the number of cables required and simplifying installation.
 - Supports up to 256 RS-485, remote-controlled cameras.
 - Pan, tilt and other lens motions can be controlled either by multiplex data over coaxial cable or RS-485 remote-control signals.
 - Cables can be up to 1,200 m long (5C-2V coaxial cable).
- S y s t e m**
- The maximum size (256 camera x 32 monitor) system requires four WJ-SX650/SX650U units.
 - Set up is simple with the Video Input and Video Output Boards, each composed of a front-access Main Board and rear-access Rear Boards.
 - Front access for Main Board and Power Supply maintenance.
 - Rich array of sequence, alarm, and scheduling features meets every surveillance need.
 - Supports up to 1,024 alarm inputs (Terminal/Camera/Recorder/Serial/Video Loss) and up to 64 alarm outputs (and also 1,024 Serial Alarm Out).
 - Storage for up to 10,000 alarms, with alarm histories downloadable to PC to facilitate management.
 - The Set-up Menu and WJ-SX650 Series Administrator Console make set up easy.
 - Fine tune management of up to 60 users* with individual level and priority settings.
- M o n i t o r s**
- Output support for up to 32 monitors (using 2 Video Output Boards).
 - Character displays show date, time, camera number, camera title and event information.
 - Set-up menus are available in seven languages: English, French, Spanish, German, Italian, Russian, and Japanese.
 - Alarm history display shows up to most recent 1,000 alarms.
- R e c o r d e r s**
(WJ-HD300A Series)
- Supports connection of up to 16 WJ-HD300A Series recorders (using 2 Video Output Boards).
 - Use of WJ-HD300A Series network features allows remote surveillance from a PC.
- C o n t r o l l e r s**
- Supports simultaneous use of up to 16 WV-CU650 System Controllers + personal computer (PC).
 - Supports use of PS•Data (With DATA1 port set to PS•Data).

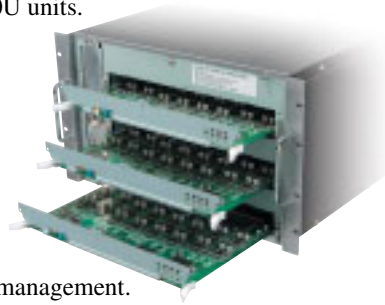

MATRIX SYSTEM 650



A Rich Array of Features for More Reliable and Efficient Surveillance



Three Sequencing Features for More Efficient Monitoring

These features allow you to determine the sequence in which you see images from multiple cameras. System Controller buttons make monitoring more efficient by enabling instant selection of the pattern of your choice.

Tour Sequence

Automatically switches camera images in preset sequences on the monitor you select. You can preset up to 32 patterns with as many as 64 steps per pattern.

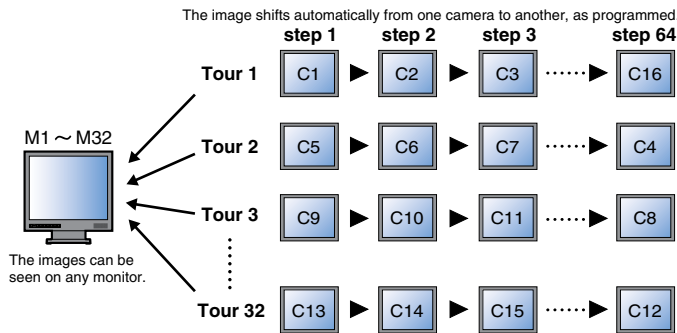

Group Sequence

Automatically switches camera images in preset sequences on up to 16 pre-selected monitors at once. You can preset up to 8 patterns with as many as 32 steps per pattern.

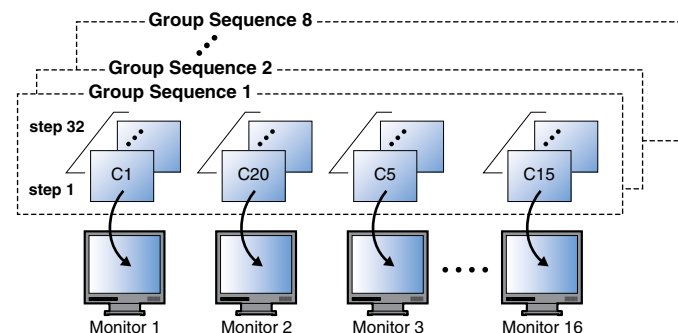

Group Preset

Allows instant spot display of selected camera images on up to 16 pre-selected monitors at once. You can preset up to 24 patterns.

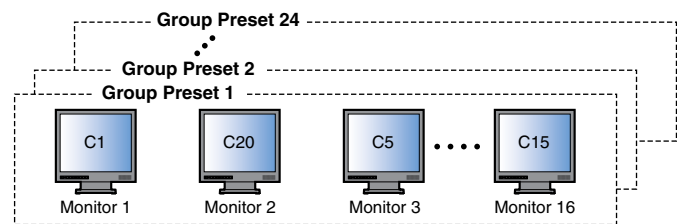

Set switching interval and other parameters for each step

Setting	Content	Note
Camera Number*	001 - 999	Your choice for up to 256 cameras
Preset*	001 - 256	Preset positions for combination cameras
AUX. 1/2	ON / OFF	To operate buzzers or other external devices
Dwell Time**	0 - 30 sec.	Image switching interval

* Can also be set using pre-registered camera position numbers.
** Not available for Group Preset since switching is occurs once.

Up to 1,024 Alarm Events Ensure That You Capture Vital Scenes

Preset camera positions, sequences and recording can be automatically activated by all types of alarm signals (Terminal, Camera, Recorder, Serial, Video Loss). Register up to 1,024 Alarm Events.

For example: Terminal Alarm Event No.256

No.	Display Mode	SPOT		Monitors	Recording Source	Alarm Output
		Camera Number	Preset			
256	SPOT	100	1	5	10	50

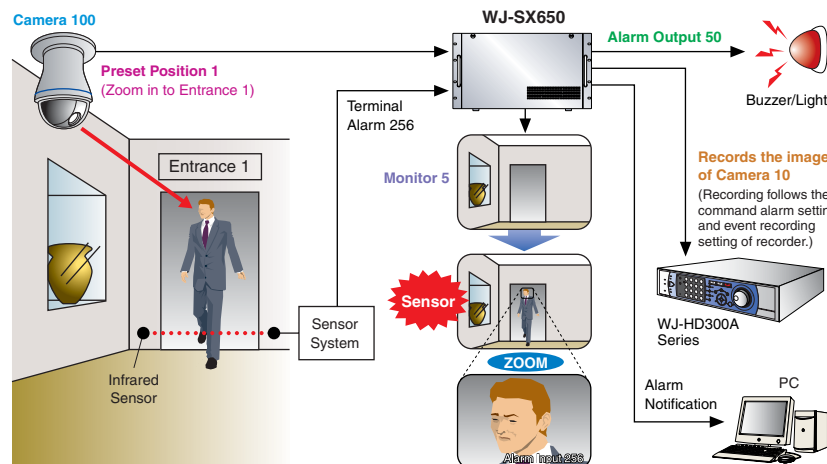

Alarm Schedule for up to 64 Alarms

Used to schedule pre-registered alarm events (ON/OFF, daily, weekly, monthly).

Four Display Modes

Alarm events can be displayed in Spot, Tour Sequence, Group Sequence or Group preset modes.

Three Alarm Modes (Spot Display Only)

Choose any of three ways to display multiple alarm event images in Spot display mode.

Sequence mode — Alarm event images displayed on monitor in the sequence in which they occurred.

Latest mode — Show latest alarm event image (Hold Last).

Earliest mode — Show earliest alarm event image (Hold First). (When alarms occur with Tour Sequence or Group Sequence/Group Preset set, earlier alarms are reset on that monitor.)

Log Up to 10,000 Alarms

Matrix System 650 can store up to 10,000 alarm events. Alarm histories can be downloaded to a PC for analysis and management. The latest 1,000 alarm events can be viewed from a surveillance monitor.

Schedules for Simple, Certain Operation

Monitors and cameras can be automatically activated at preset dates and times using Daily, Weekly, and Monthly modes.

Timer Events

Spot, Tour Sequence and Group Sequence/Group Preset features can be automatically activated on designated monitors, following preset schedules. Up to 128 timer events can be registered and assigned priorities.

Camera Events

Designated cameras can be set for automatic tracking*, B/W switching and scene switching [PATROL(S)]*, and cleaning, following preset schedules. Up to 128 camera events can be registered.

* For WV-CS950 camera series only.

PROGRAM	ACTIVE PERIOD DESIGNATION	TIME	SCHEDULE MODE	ACTION	Timer Event		Camera Event	
					MONITOR	PRIORITY	MONITOR	PRIORITY
1	JUL.19.2005 ~ JUL.23.2005	9:00 ~ 16:00	DAILY	TOUR SEQ	1 ~ 32	1 ~ 99		
2	Always Active	10:00 ~ 17:00	WEEKLY (SUN)	GROUP SEQ	1 ~ 32	1 ~ 99		
3	JAN.1.2005 ~ DEC.1.2005	22:00 ~ 01:00	MONTHLY (1)	CAMERA CLEANING (ALL CAMERA)				
...								
128	DEC.1.2005 ~ DEC.23.2005	12:00 ~ 17:00	MONTHLY (1)	GROUP PRESET	1 ~ 32	1 ~ 99		

The Camera You Need to Take Full Advantage of Camera Events

SDIII
Super Dynamic III
Colour Dome Cameras
WV-CS950 Series



All 256 Channels with Multiplex Data Over Coaxial Cables

To simplify installation and for smoother system expansion, video signals, control data, synchronous signals (VD2) and alarm signals are all transmitted over the same coaxial cable. Cables can be up to 1,200 m long (5C-2V coaxial cable).

VD2 Compatible Panasonic Camera List

B/W Camera	WV-BP330 Series
Colour Camera	WV-CW480 Series, WV-CW240 Series, WV-CF324, WV-CF284/294 Series, WV-CP480 Series, WV-CW380 Series, WV-CL930 Series, WV-CP250 Series, WV-CP280 Series
Integrated Dome Camera	WV-CS950 Series, WV-CW960/970 Series, WV-CS570 Series

Since 1988, most of Panasonic cameras have been designed and manufactured to accept VD2 signal for system integration.

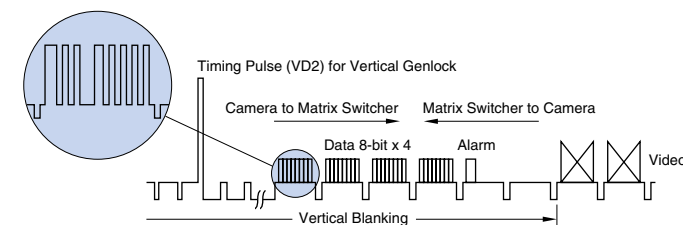

High Image Quality and High Capacity Storage

When connected to the Panasonic WJ-HD300A Series Digital Disk Recorder, Matrix System 650 can be used to construct surveillance systems that offer both high image quality and high capacity image storage. WJ-HD300A Series Digital Disk Recorders can be operated seamlessly from Matrix System 650's WV-CU650 System Controller, to support multi-screen monitoring and high-speed Filtered Search. These digital disk recorders' networking features also allow remote control from a PC.

Digital Disk Recorders
WJ-HD300A Series



Preventing Unauthorized Access

Up to 60 users* can be registered with individual user IDs and passwords. Security can be fine-tuned with individual level, priority and camera/recorder display and operation restrictions, to guard against unauthorized access and unauthorized changes in settings.

* 1 of the 60 users is reserved for recorder control.

Operator Registration

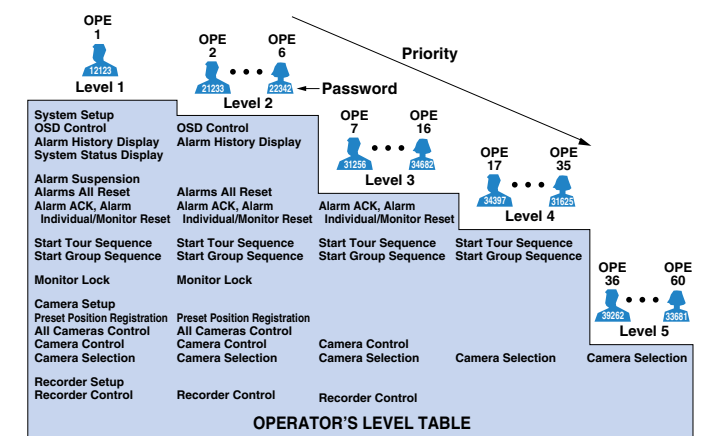

Rich Array of Display Options

Use of a newly developed LSI allows you to choose from any of seven languages (English, French, Spanish, German, Italian, Russian, or Japanese) when setting up a system. When monitoring date and time, camera title, monitor status, and event information can all be displayed. Camera titles can include roman alphabet, special alphabet (German or Russian), numbers, symbols, and Chinese and Japanese characters (approx. 1,000).

Example of Character Displays

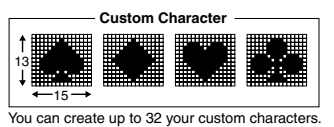
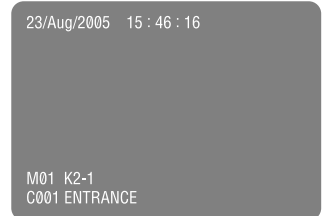

Matrix Switcher: WJ-SX650 / Card Cage: WJ-SX650U

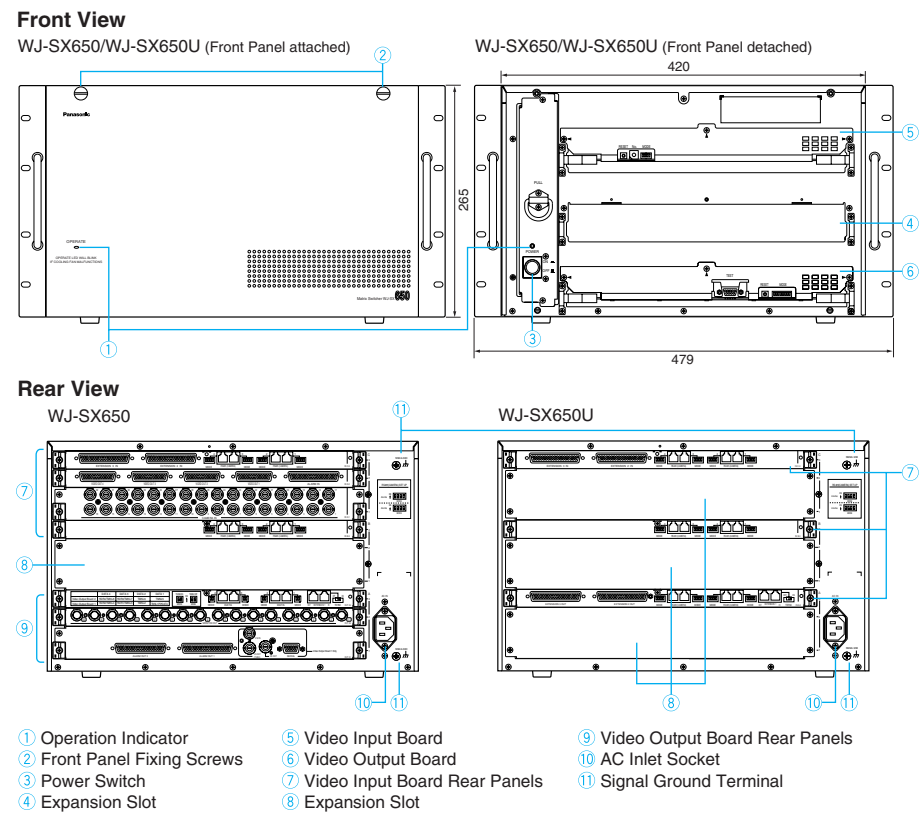

SPECIFICATIONS	
Matrix Switcher: WJ-SX650	
Power Source	220 V - 240 V, 50 Hz
Power Consumption	60 W
Ambient Operating Temperature	-10 °C to +50 °C
Ambient Operating Humidity	Less than 90 %
Video Input Board	x 1
Video Output Board	x 1
Expansion Slot	x 1
RS-485 (Camera) Port	6-conductor modular jack x 4 (2-wire or 4-wire communication, With termination switches (MODE 1 to 4))
Functions	Monitor control (Camera selection, tour sequence, group preset, OSD display), Camera/Receiver control (Coaxial/RS-485 communication), Recorder control, Alarm control (Alarm event, Alarm ACK, Alarm reset, Alarm suspension, Alarm History Display), Timer event, Camera event
Dimensions (W x H x D)	420 mm x 265 mm x 372 mm (excluding rubber feet and projections)
Weight	19.0 kg
Card Cage: WJ-SX650U	
Expansion Slot	x 3
RS-485 (Camera) Port	6-conductor modular jack x 12 (2-wire or 4-wire communication, With termination switches (MODE 1 to 4))
Extension Port (EXTENSION 1 IN, OUT)	6-conductor modular jack x 2 (With a termination switch (TERM: ON, OFF))
Extension Port (EXTENSION IN 2, 3)	37-pin D-sub connector x 2
Extension Port (EXTENSION OUT 2, 3)	37-pin D-sub connector x 2
Dimensions (W x H x D)	420 mm x 265 mm x 372 mm (excluding rubber feet and projections)
Weight	18.0 kg

Video Input Board: WJ-PB65C32

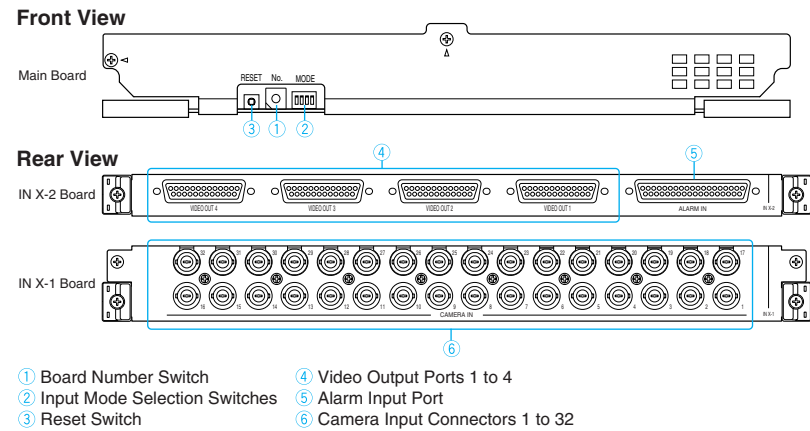

SPECIFICATIONS	
Camera Input (CAMERA IN 1 to 32)	1 V [p-p] / 75 Ω (BNC x 32), composite video signal 0.5 V [p-p] / 75 Ω data signal and 2.5 V [p-p] / 75 Ω vertical timing pulse multiplexed
Video Output (VIDEO OUT 1 to 4)	1 V [p-p] / 75 Ω (25-pin D-sub connector x 4), active loop-thru output
Alarm Input (ALARM IN)	N.O. (Normally Open contact) or N.C. (Normally Close contact) selectable x 32 (37-pin D-sub connector)
Dimensions (W x H x D)	
Main Board	346 mm x 42 mm x 225 mm
IN X-2 Board	355 mm x 21 mm x 115 mm
IN X-1 Board	355 mm x 38 mm x 115 mm

Video Output Board: WJ-PB65M16

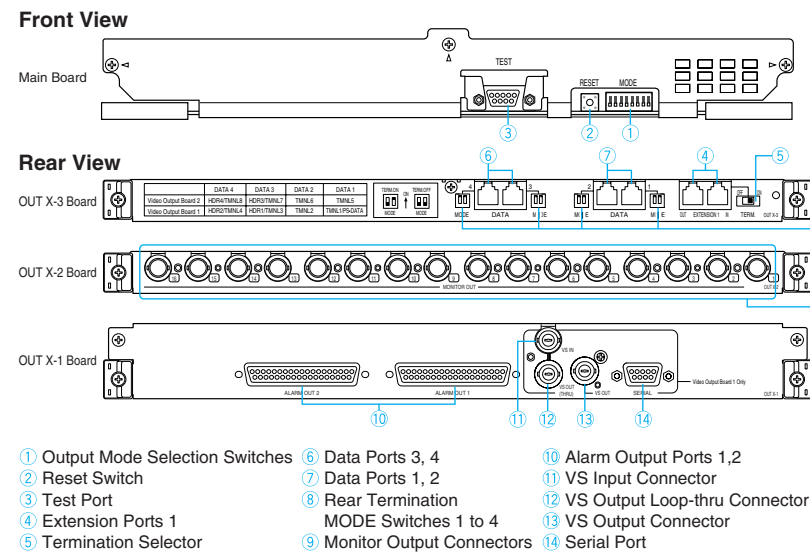

SPECIFICATIONS	
Monitor Output (MONITOR OUT 1 to 16)	1 V [p-p] / 75 Ω (BNC x 16)
Data Port (DATA 1 to 4)	
DATA 1	Terminal Mode (TMNL)/PS-Data (PS-DATA) selectable
DATA 2	Terminal Mode (TMNL)
DATA 3, 4	Terminal Mode (TMNL)/Digital Disk Recorder (HDR) selectable
Alarm Output (ALARM OUT 1, 2)	6-conductor modular jack x 4 (With termination switches (MODE 1 to 4))
Alarm Output	Open collector output x 32, Max. 24 V DC, 100 mA
Alarm Recover Input	Non-voltage make contact input x 16
Time Adjust Input	Non-voltage make contact input x 1
Time Adjust Output	Open collector output x 32, Max. 24 V DC, 100 mA
Extension Port (EXTENSION 1 IN, OUT)	6-conductor modular jack x 2 (With a termination switch (TERM: ON, OFF))
VS Input	1 V [p-p] / 75 Ω (VS IN)
VS Output	(VS OUT (THRU)): VS loop-thru output, (VS OUT): 1 V [p-p] / 75 Ω (VS)
Serial Port	9-pin D-sub connector x 2
Dimensions (W x H x D)	
Main Board	346 mm x 42 mm x 225 mm
OUT X-3 Board	355 mm x 21 mm x 115 mm
OUT X-2 Board	355 mm x 21 mm x 115 mm
OUT X-1 Board	355 mm x 38 mm x 115 mm

1 Basic System

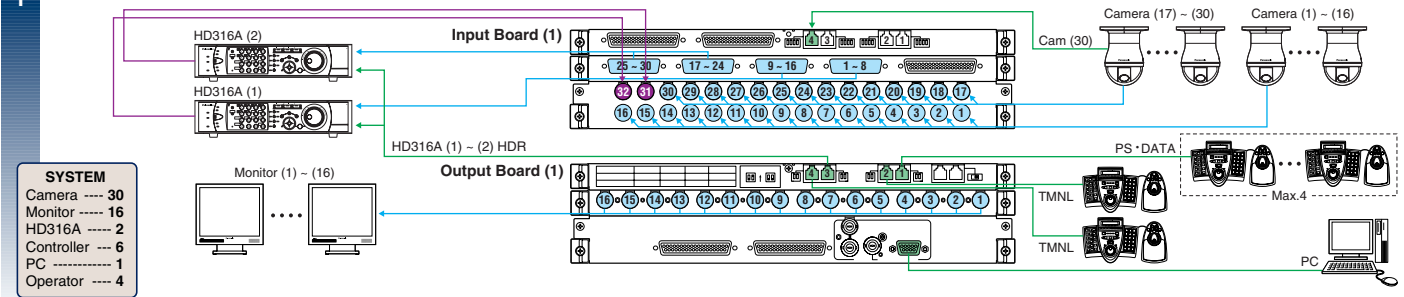

2 Medium-sized System

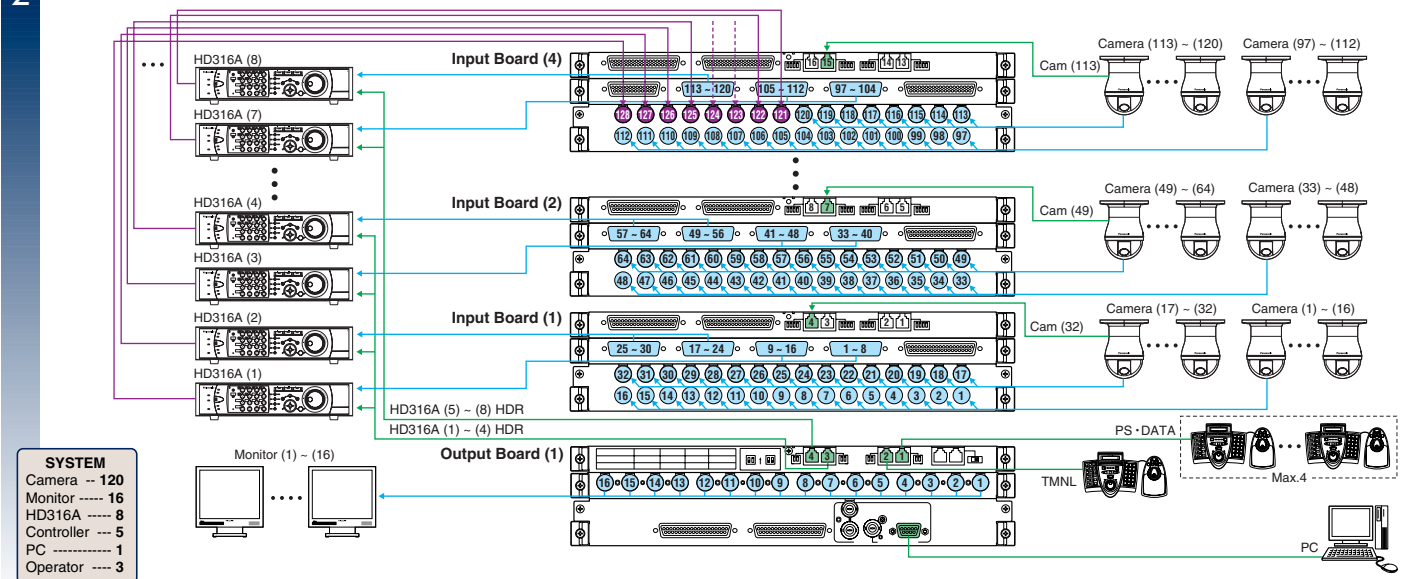

3 Maximum-sized 256-camera System (Image playback is only possible on the monitors connected WJ-HD300A Series Digital Disk Recorders)

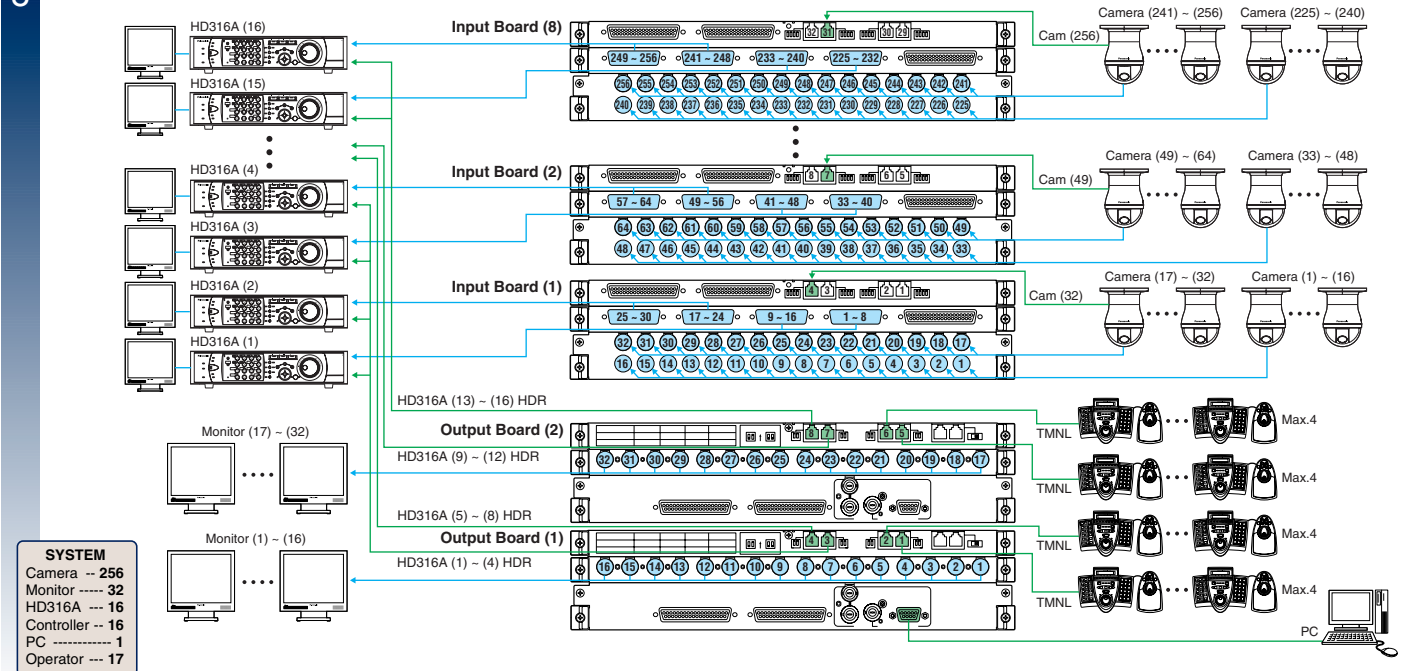

4 WJ-HD300A Series Web Control System

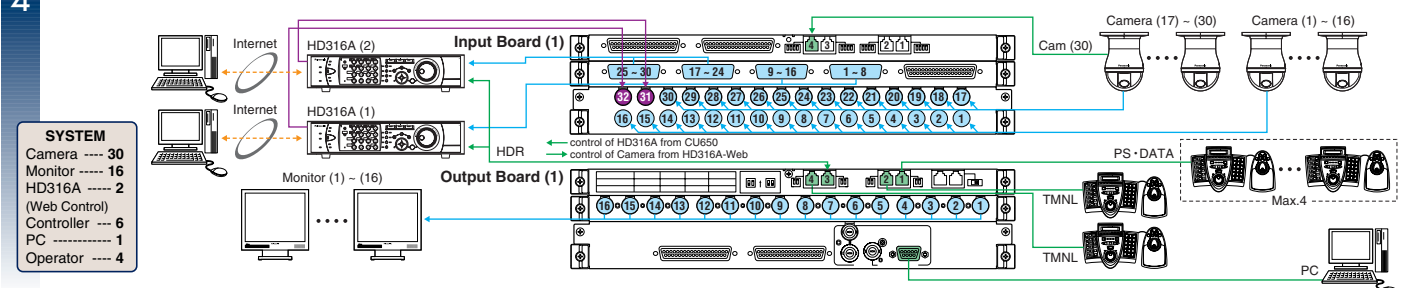

VIDEO INPUT/OUTPUT BOARD COMBINATION

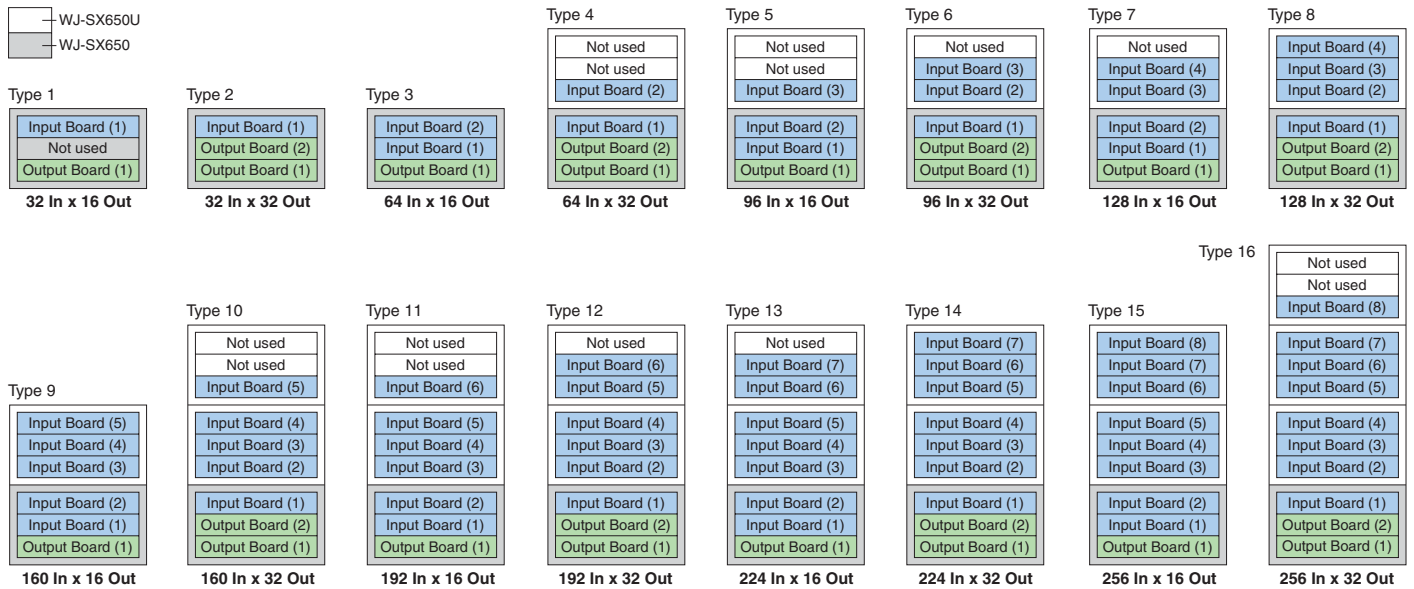

MATRIX SYSTEM650 PRODUCT COMPONENTS

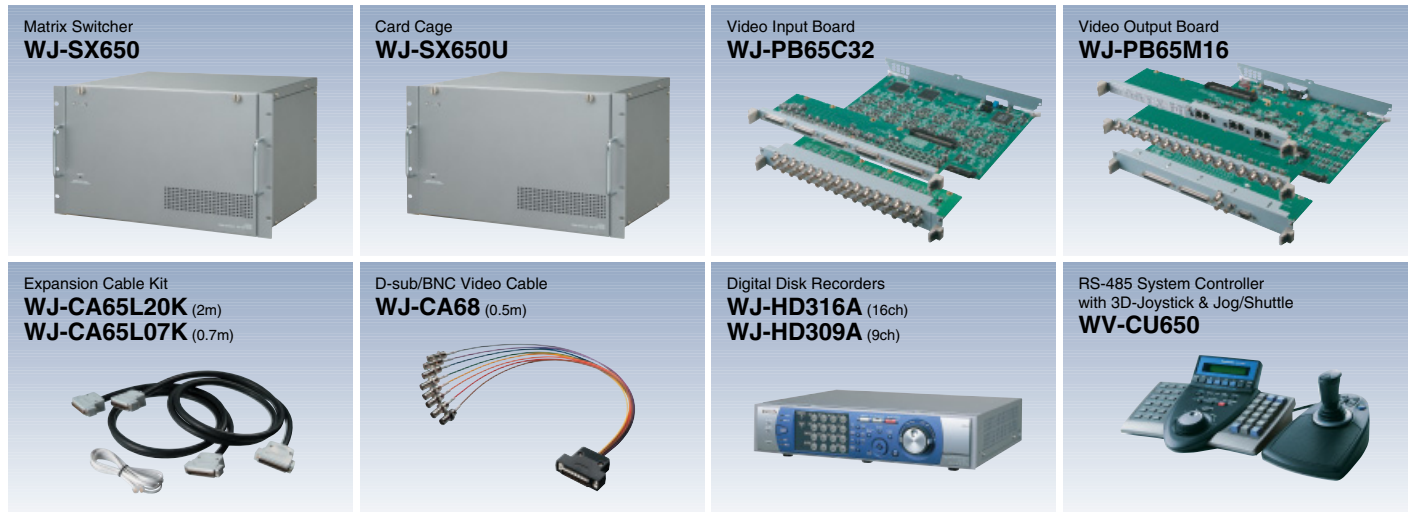

Trademarks and registered trademarks

– Microsoft, and Windows are registered trademarks of Microsoft Corporation in the U.S. and other countries.

Important

- Safety Precaution: carefully read the operating instructions and installation manual before using this product.
- Panasonic can not be responsible for network performance and/or other manufacturer products that reside on the network.

- All TV pictures are simulated.
- Weights and dimensions are approximate.
- Specifications are subject to change without notice.
- These products may be subject to export control regulations.

DISTRIBUTED BY:

Panasonic[®]

<http://panasonic.net/security/>

Printed in Japan (2N-752A)