



# **Video Intercom Kit**

**User Manual**

## Legal Information

©2023 Hangzhou Hikvision Digital Technology Co., Ltd. All rights reserved.

### About this Manual

The Manual includes instructions for using and managing the Product. Pictures, charts, images and all other information hereinafter are for description and explanation only. The information contained in the Manual is subject to change, without notice, due to firmware updates or other reasons. Please find the latest version of this Manual at the Hikvision website ( <https://www.hikvision.com/> ).

Please use this Manual with the guidance and assistance of professionals trained in supporting the Product.

### Trademarks

**HIKVISION** and other Hikvision's trademarks and logos are the properties of Hikvision in various jurisdictions.

Other trademarks and logos mentioned are the properties of their respective owners.

### Disclaimer

TO THE MAXIMUM EXTENT PERMITTED BY APPLICABLE LAW, THIS MANUAL AND THE PRODUCT DESCRIBED, WITH ITS HARDWARE, SOFTWARE AND FIRMWARE, ARE PROVIDED "AS IS" AND "WITH ALL FAULTS AND ERRORS". HIKVISION MAKES NO WARRANTIES, EXPRESS OR IMPLIED, INCLUDING WITHOUT LIMITATION, MERCHANTABILITY, SATISFACTORY QUALITY, OR FITNESS FOR A PARTICULAR PURPOSE. THE USE OF THE PRODUCT BY YOU IS AT YOUR OWN RISK. IN NO EVENT WILL HIKVISION BE LIABLE TO YOU FOR ANY SPECIAL, CONSEQUENTIAL, INCIDENTAL, OR INDIRECT DAMAGES, INCLUDING, AMONG OTHERS, DAMAGES FOR LOSS OF BUSINESS PROFITS, BUSINESS INTERRUPTION, OR LOSS OF DATA, CORRUPTION OF SYSTEMS, OR LOSS OF DOCUMENTATION, WHETHER BASED ON BREACH OF CONTRACT, TORT (INCLUDING NEGLIGENCE), PRODUCT LIABILITY, OR OTHERWISE, IN CONNECTION WITH THE USE OF THE PRODUCT, EVEN IF HIKVISION HAS BEEN ADVISED OF THE POSSIBILITY OF SUCH DAMAGES OR LOSS.

YOU ACKNOWLEDGE THAT THE NATURE OF THE INTERNET PROVIDES FOR INHERENT SECURITY RISKS, AND HIKVISION SHALL NOT TAKE ANY RESPONSIBILITIES FOR ABNORMAL OPERATION, PRIVACY LEAKAGE OR OTHER DAMAGES RESULTING FROM CYBER-ATTACK, HACKER ATTACK, VIRUS INFECTION, OR OTHER INTERNET SECURITY RISKS; HOWEVER, HIKVISION WILL PROVIDE TIMELY TECHNICAL SUPPORT IF REQUIRED.

YOU AGREE TO USE THIS PRODUCT IN COMPLIANCE WITH ALL APPLICABLE LAWS, AND YOU ARE SOLELY RESPONSIBLE FOR ENSURING THAT YOUR USE CONFORMS TO THE APPLICABLE LAW. ESPECIALLY, YOU ARE RESPONSIBLE, FOR USING THIS PRODUCT IN A MANNER THAT DOES NOT INFRINGE ON THE RIGHTS OF THIRD PARTIES, INCLUDING WITHOUT LIMITATION, RIGHTS OF PUBLICITY, INTELLECTUAL PROPERTY RIGHTS, OR DATA PROTECTION AND OTHER PRIVACY RIGHTS. YOU SHALL NOT USE THIS PRODUCT FOR ANY PROHIBITED END-USES, INCLUDING THE

DEVELOPMENT OR PRODUCTION OF WEAPONS OF MASS DESTRUCTION, THE DEVELOPMENT OR PRODUCTION OF CHEMICAL OR BIOLOGICAL WEAPONS, ANY ACTIVITIES IN THE CONTEXT RELATED TO ANY NUCLEAR EXPLOSIVE OR UNSAFE NUCLEAR FUEL-CYCLE, OR IN SUPPORT OF HUMAN RIGHTS ABUSES.

IN THE EVENT OF ANY CONFLICTS BETWEEN THIS MANUAL AND THE APPLICABLE LAW, THE LATTER PREVAILS.



### **Data Protection**

During the use of device, personal data will be collected, stored and processed. To protect data, the development of Hikvision devices incorporates privacy by design principles. For example, for device with facial recognition features, biometrics data is stored in your device with encryption method; for fingerprint device, only fingerprint template will be saved, which is impossible to reconstruct a fingerprint image.

As data controller, you are advised to collect, store, process and transfer data in accordance with the applicable data protection laws and regulations, including without limitation, conducting security controls to safeguard personal data, such as, implementing reasonable administrative and physical security controls, conduct periodic reviews and assessments of the effectiveness of your security controls.

## Symbol Conventions

The symbols that may be found in this document are defined as follows.

Symbol	Description
 <b>Danger</b>	Indicates a hazardous situation which, if not avoided, will or could result in death or serious injury.
 <b>Caution</b>	Indicates a potentially hazardous situation which, if not avoided, could result in equipment damage, data loss, performance degradation, or unexpected results.
 <b>Note</b>	Provides additional information to emphasize or supplement important points of the main text.

## Safety Instruction

### **Warning**

- All the electronic operation should be strictly compliance with the electrical safety regulations, fire prevention regulations and other related regulations in your local region.
- Please use the power adapter, which is provided by normal company. The power consumption cannot be less than the required value.
- Do not connect several devices to one power adapter as adapter overload may cause over-heat or fire hazard.
- Please make sure that the power has been disconnected before you wire, install or dismantle the device.
- When the product is installed on wall or ceiling, the device shall be firmly fixed.
- If smoke, odors or noise rise from the device, turn off the power at once and unplug the power cable, and then please contact the service center.
- If the product does not work properly, please contact your dealer or the nearest service center. Never attempt to disassemble the device yourself. (We shall not assume any responsibility for problems caused by unauthorized repair or maintenance.)

### **Caution**

- Do not drop the device or subject it to physical shock, and do not expose it to high electromagnetism radiation. Avoid the equipment installation on vibrations surface or places subject to shock (ignorance can cause equipment damage).
- Do not place the device in extremely hot (refer to the specification of the device for the detailed operating temperature), cold, dusty or damp locations, and do not expose it to high electromagnetic radiation.
- The device cover for indoor use shall be kept from rain and moisture.
- Exposing the equipment to direct sun light, low ventilation or heat source such as heater or radiator is forbidden (ignorance can cause fire danger).
- Do not aim the device at the sun or extra bright places. A blooming or smear may occur otherwise (which is not a malfunction however), and affecting the endurance of sensor at the same time.
- Please use the provided glove when open up the device cover, avoid direct contact with the device cover, because the acidic sweat of the fingers may erode the surface coating of the device cover.
- Please use a soft and dry cloth when clean inside and outside surfaces of the device cover, do not use alkaline detergents.
- Please keep all wrappers after unpack them for future use. In case of any failure occurred, you need to return the device to the factory with the original wrapper. Transportation without the original wrapper may result in damage on the device and lead to additional costs.

## Video Intercom Kit User Manual

---

- Improper use or replacement of the battery may result in hazard of explosion. Replace with the same or equivalent type only. Dispose of used batteries according to the instructions provided by the battery manufacturer.
- Input voltage should meet both the SELV and the Limited Power Source according to 60950-1 standard.
- The power supply must conform to LPS. The recommended adaptor models and manufacturers are shown as below. Use the attached adapter, and do not change the adaptor randomly.

<b>Model</b>	<b>Manufacturer</b>	<b>Standard</b>
ADS-24S-12 1224GPCN	SHENZHEN HONOR ELECTRONIC CO.,LTD	CEE
G0549-240-050	SHENZHEN GOSPELL DIGITAL TECHNOLOGY CO.,LTD	CEE
TS-A018-120015Ec	SHENZHEN TRANSIN TECHNOLOGIES CO., LTD	CEE

## Regulatory Information

### EU Conformity Statement



This product and - if applicable - the supplied accessories too are marked with "CE" and comply therefore with the applicable harmonized European standards listed under the EMC Directive 2014/30/EU, RE Directive 2014/53/EU, the RoHS Directive 2011/65/EU



2012/19/EU (WEEE directive): Products marked with this symbol cannot be disposed of as unsorted municipal waste in the European Union. For proper recycling, return this product to your local supplier upon the purchase of equivalent new equipment, or dispose of it at designated collection points. For more information see: [www.recyclethis.info](http://www.recyclethis.info)



2006/66/EC (battery directive): This product contains a battery that cannot be disposed of as unsorted municipal waste in the European Union. See the product documentation for specific battery information. The battery is marked with this symbol, which may include lettering to indicate cadmium (Cd), lead (Pb), or mercury (Hg). For proper recycling, return the battery to your supplier or to a designated collection point. For more information see: [www.recyclethis.info](http://www.recyclethis.info)

### Industry Canada ICES-003 Compliance

This device meets the CAN ICES-3 (B)/NMB-3(B) standards requirements.

This device complies with Industry Canada licence-exempt RSS standard(s). Operation is subject to the following two conditions:

1. this device may not cause interference, and
2. this device must accept any interference, including interference that may cause undesired operation of the device.

Le présent appareil est conforme aux CNR d'Industrie Canada applicables aux appareils radioexempts de licence. L'exploitation est autorisée aux deux conditions suivantes :

1. l'appareil ne doit pas produire de brouillage, et
2. l'utilisateur de l'appareil doit accepter tout brouillage radioélectrique subi, même si le brouillage est susceptible d'en compromettre le fonctionnement.

Under Industry Canada regulations, this radio transmitter may only operate using an antenna of a type and maximum (or lesser) gain approved for the transmitter by Industry Canada. To reduce potential radio interference to other users, the antenna type and its gain should be so chosen that the equivalent isotropically radiated power (e.i.r.p.) is not more than that necessary for successful communication.

## Video Intercom Kit User Manual

---

Conformément à la réglementation d'Industrie Canada, le présent émetteur radio peut fonctionner avec une antenne d'un type et d'un gain maximal (ou inférieur) approuvé pour l'émetteur par Industrie Canada. Dans le but de réduire les risques de brouillage radioélectrique à l'intention des autres utilisateurs, il faut choisir le type d'antenne et son gain de sorte que la puissance isotrope rayonnée équivalente (p.i.r.e.) ne dépasse pas l'intensité nécessaire à l'établissement d'une communication satisfaisante.

This equipment should be installed and operated with a minimum distance 20cm between the radiator and your body.

Cet équipement doit être installé et utilisé à une distance minimale de 20 cm entre le radiateur et votre corps.



# Contents

<b>Chapter 1 About this Manual .....</b>	<b>1</b>
<b>Chapter 2 Introduction .....</b>	<b>2</b>
<b>Chapter 3 Appearance .....</b>	<b>3</b>
<b>Chapter 4 Terminal and Wiring Description .....</b>	<b>5</b>
4.1 Terminal Description .....	5
4.2 Wiring Description .....	9
<b>Chapter 5 Installation .....</b>	<b>11</b>
5.1 Install Indoor Station .....	11
5.1.1 Wall Mounting with Junction Box .....	11
5.1.2 Mounting Indoor Station without Junction Box .....	12
5.2 Install Doorbell .....	13
<b>Chapter 6 Activation .....</b>	<b>16</b>
6.1 Activate Indoor Station .....	16
<b>Chapter 7 Configuration .....</b>	<b>17</b>
7.1 Local Operation .....	17
7.1.1 Quick Operation .....	17
7.1.2 Basic Settings .....	23
7.1.3 Password Settings .....	34
7.1.4 Synchronize Time .....	36
7.1.5 Sound Settings .....	37
7.1.6 Link to the Mobile Client .....	40
7.1.7 System Settings .....	41
7.1.8 Output Settings .....	44
7.1.9 Device Information .....	45
<b>Chapter 8 Operation .....</b>	<b>46</b>
8.1 Local Operation .....	46

# Video Intercom Kit User Manual

---

8.1.1 Call Settings .....	46
8.1.2 Leave Message .....	49
8.1.3 Live View .....	49
8.1.4 Arm/Disarm .....	51
8.1.5 Call Elevator .....	53
8.1.6 Relay Settings .....	54
8.1.7 Information Management .....	54
<b>Appendix A. Cables .....</b>	<b>56</b>

## Chapter 1 About this Manual

Get the manual and related software from or the official website (<http://www.hikvision.com>).

Product	Model
Network Indoor Station	DS-KH6320-WTDE1
Doorphone	DS-KB2421T-IM

## Chapter 2 Introduction

Features of the hybrid video intercom products:

- User-friendly control with a convenient touch screen.
- Convenient management via the Hik-Connect mobile client.
- More cost-effective options with analog doorbells.
- Easy installation as the doorbell requires no exclusive power supply.

## Chapter 3 Appearance

### Network Indoor Station

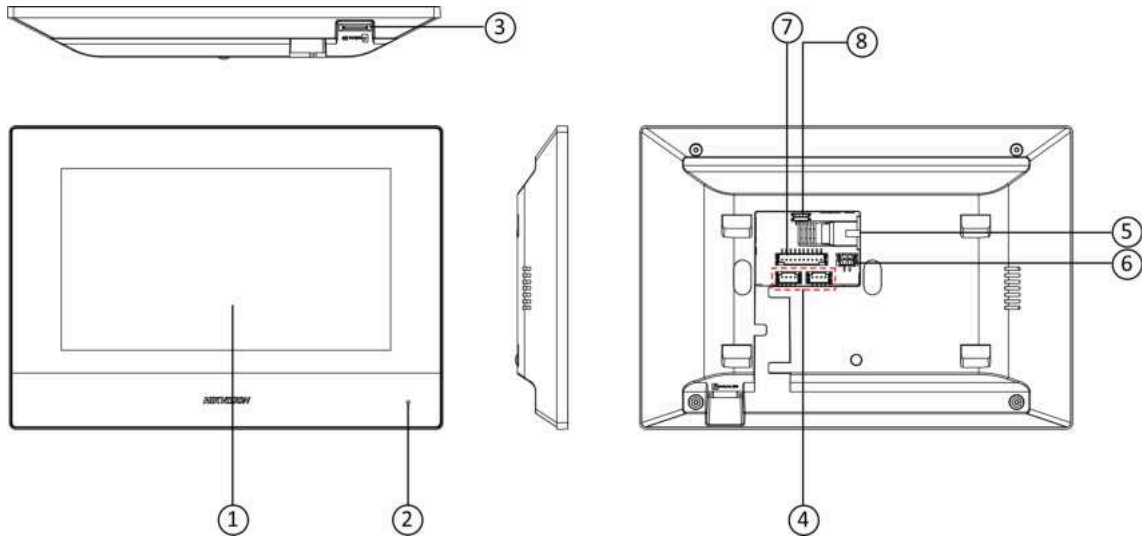
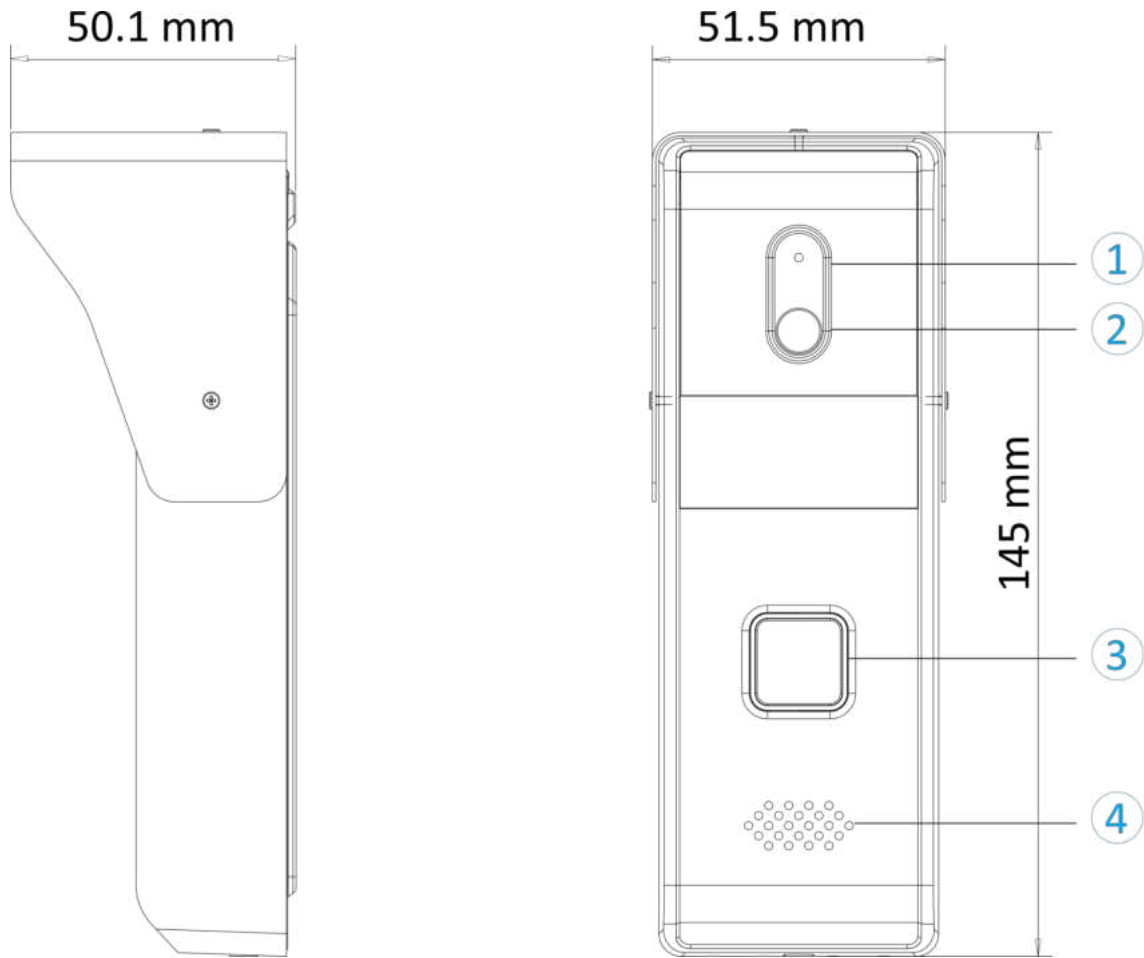

Figure 3-1 Appearance of Indoor Station

Table 3-1 Description

No.	Description
1	Screen
2	Microphone
3	SD Card Slot
4	Four-Wire Terminals
5	Network Interface
6	Power Supply Interface
7	Alarm Input/Relay Output/RS-485 Interface
8	Serial Port (For Debugging Use Only)

**Doorphone**



**Figure 3-2 Appearance of Doorphone**

**Table 3-2 Description**

No.	Description
1	Microphone
2	Built-in Camera
3	Call Button
4	Loud Speaker

## Chapter 4 Terminal and Wiring Description

### 4.1 Terminal Description



Note

You can refer to Appendix for more details about cable specification.

#### Network Indoor Station Wiring

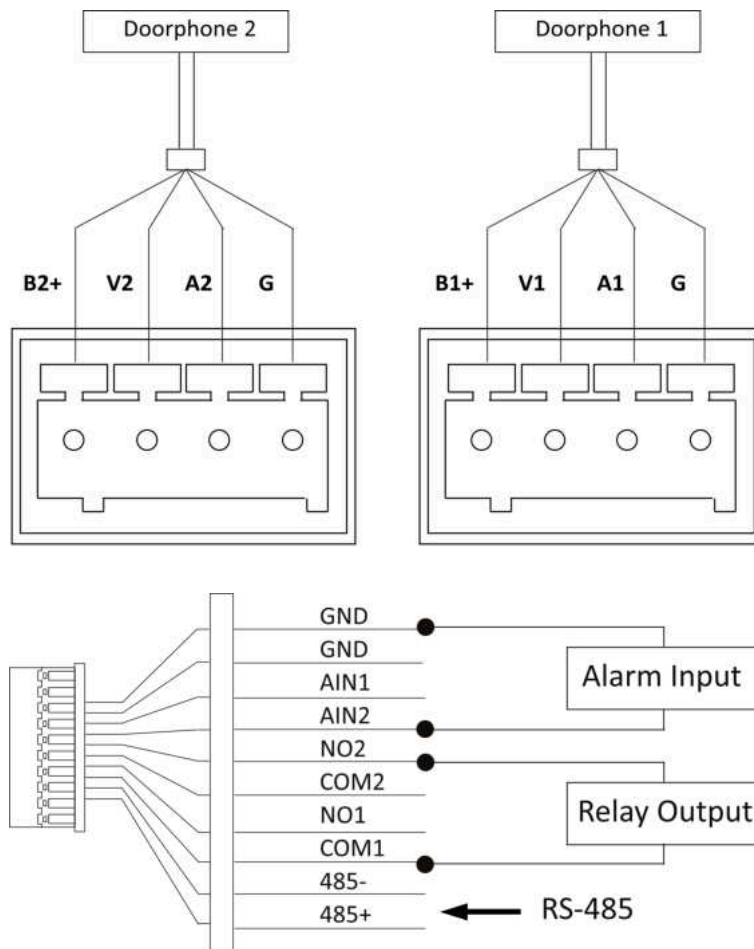

Figure 4-1 Terminal of Indoor Station

**Table 4-1 Descriptions of Terminal and Interfaces**

Interface	Description	Function
B1+	12 VDC Power supply for doorphone 1	For the connection of doorphone 1
V1	Video input of doorphone 1	
A1	Audio input/output of doorphone 1	
G	Grounding	
B2+	12 VDC Power supply for doorphone 2	For the connection of doorphone 2
V2	Video input of doorphone 2	
A2	Audio input/output of doorphone 2	
G	Grounding	
GND	Grounding	For the connection of alarm input devices
AIN1	Alarm input 1	
AIN2	Alarm input 2	
COM1	Door lock relay output 1 (common)	For the connection of door locks
NO1	Door lock relay output 1 (normally open)	
COM2	Door lock relay output 2 (common)	
NO2	Door lock relay output 2 (normally open)	



## Video Intercom Kit User Manual

---

Interface	Description	Function
485+	RS-485+ Interface	For the connection of devices via RS-485
485-	RS-485- Interface	

### Doorphone Wiring

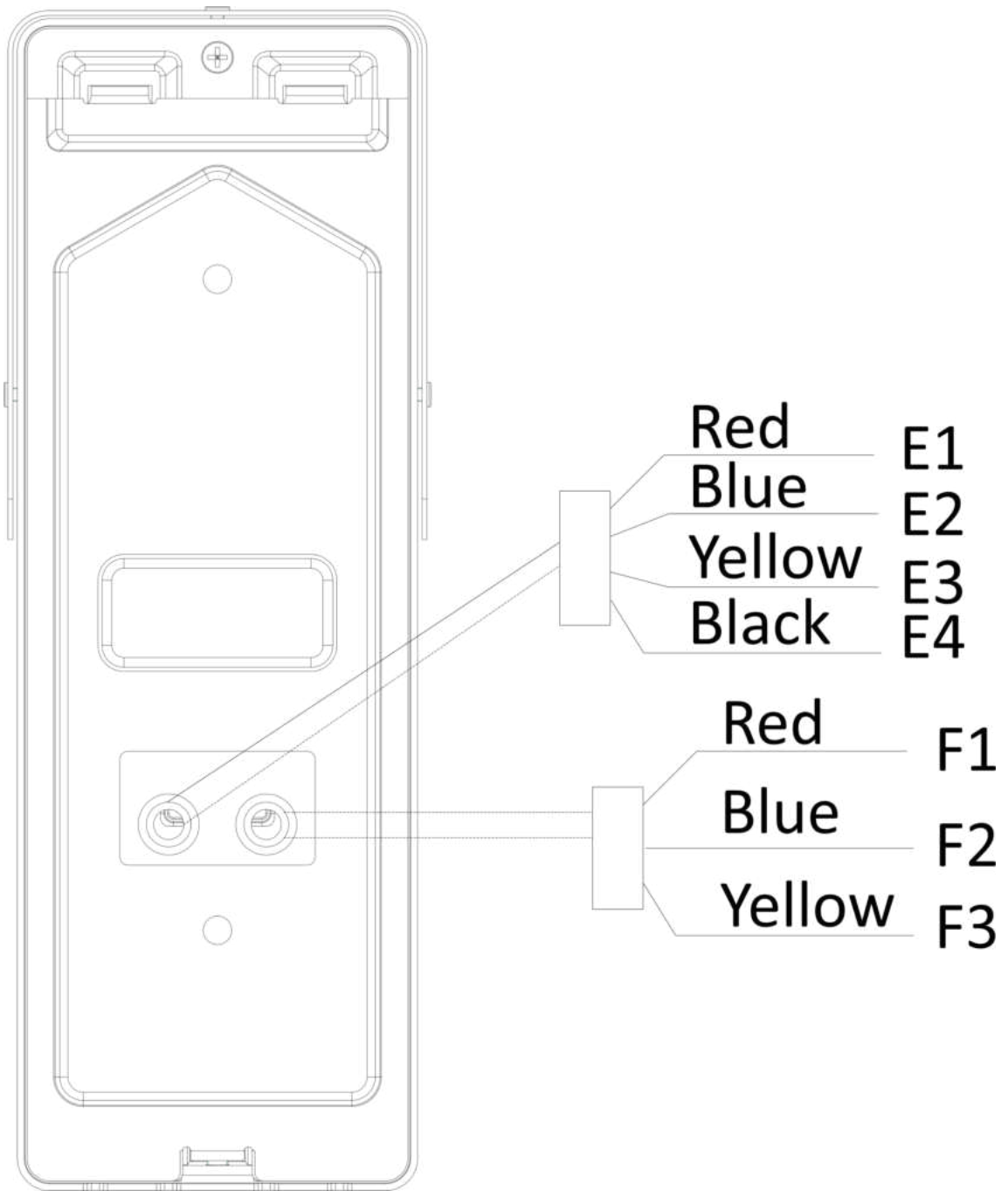

Figure 4-2 Terminal of Doorphone

**Table 4-2 Descriptions of Terminal and Interfaces**

Interface	Description	Function
E1	5V: Power Supply (from Indoor Station)	For the connection of indoor station
E2	CVBS: Video Output	
E3	AUDIO: Audio Input/Output	
E4	GND: Grounding Signal	
F1	NO: Door Lock Relay Output/ Normally Open	For the connection of door lock
F2	COM: Door Lock Relay Output/ Common	
F3	NC: Door Lock Relay Output/ Normally Closed	

## 4.2 Wiring Description

The Typical application is shown as below.



### **Caution**

Make sure all the related equipment is power-off during the wiring and installation.

---

## Typical Application

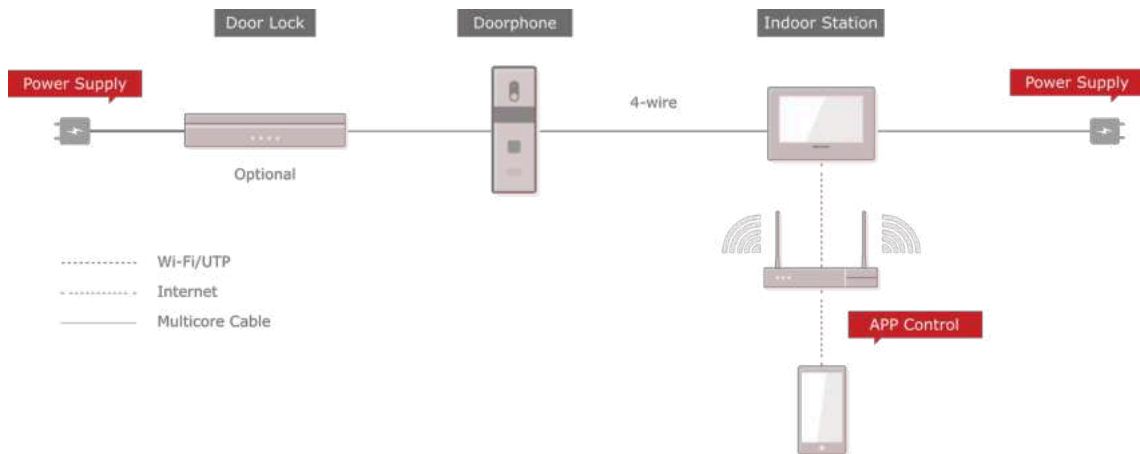

**Figure 4-3 Topology**

---

### Note

- Network indoor station can be connected to LAN(PoE) with Network Cable.
-

## Chapter 5 Installation

### 5.1 Install Indoor Station

#### 5.1.1 Wall Mounting with Junction Box

##### Before You Start

---

##### Note

- Make sure the device in the package is in good condition and all the assembly parts are included.
  - The power supply the indoor station supports is 12 VDC. Please make sure your power supply matches your indoor station.
  - Make sure all the related equipment is power-off during the installation.
  - Check the product specification for the installation environment.
- 

The dimension of junction box should be 75 mm (width) × 75 mm (length) × 50 mm (depth). The dimension of wall mounting plate is shown.

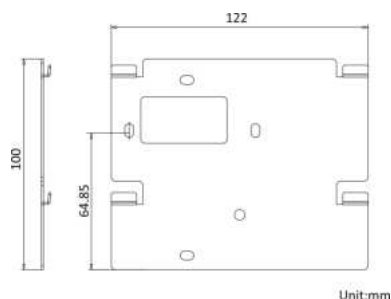

**Figure 5-1 Wall Mounting Plate**

##### Steps

1. Chisel a hole in the wall. The size of the hole should be 76 mm (width) × 76 mm (length) × 50 mm (depth).
2. Insert the junction box to the hole chiseled on the wall.
3. Fix the wall mounting plate to the junction box with 2 screws.
4. Hook the indoor station to the wall mounting plate tightly by inserting the plate hooks into the slots on the rear panel of the indoor station, during which the lock catch will be locked automatically.

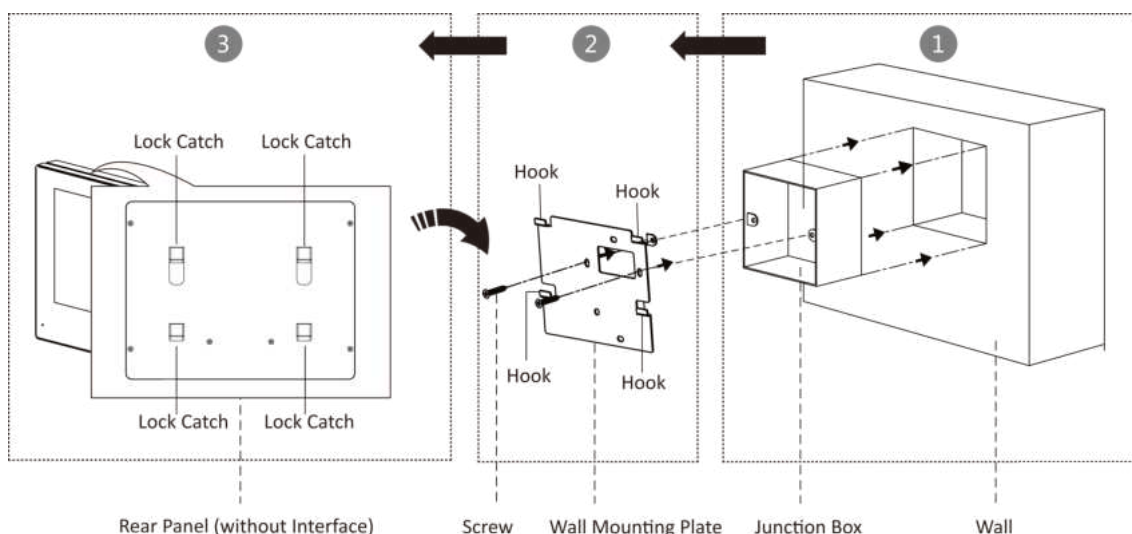

**Figure 5-2 Wall Mounting with Junction Box**

## 5.1.2 Mounting Indoor Station without Junction Box

### Before You Start



#### Note

- Make sure the device in the package is in good condition and all the assembly parts are included.
- The power supply the indoor station supports is 12 VDC. Please make sure your power supply matches your indoor station.
- Make sure all the related equipment is power-off during the installation.
- Check the product specification for the installation environment.

### Steps

1. Insert 2 expansion tubes into the wall.
2. Fix the wall mounting plate to the junction box with 2 screws.
3. Hook the indoor station to the wall mounting plate tightly by inserting the plate hooks into the slots on the rear panel of the indoor station, during which the lock catch will be locked automatically.

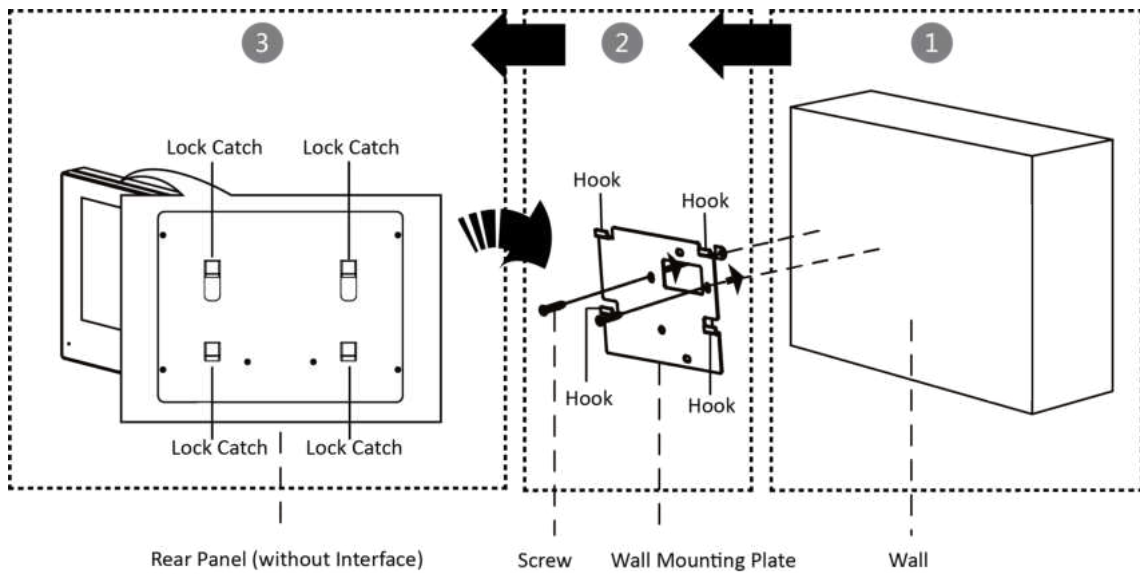

**Figure 5-3 Wall Mounting without Junction Box**

## 5.2 Install Doorbell

### Before You Start

- Make sure you have powered off the main power switch of your home.
- Make sure you have connected power cables of the doorbell.

The Dimension of the wall mounting plate is shown below.

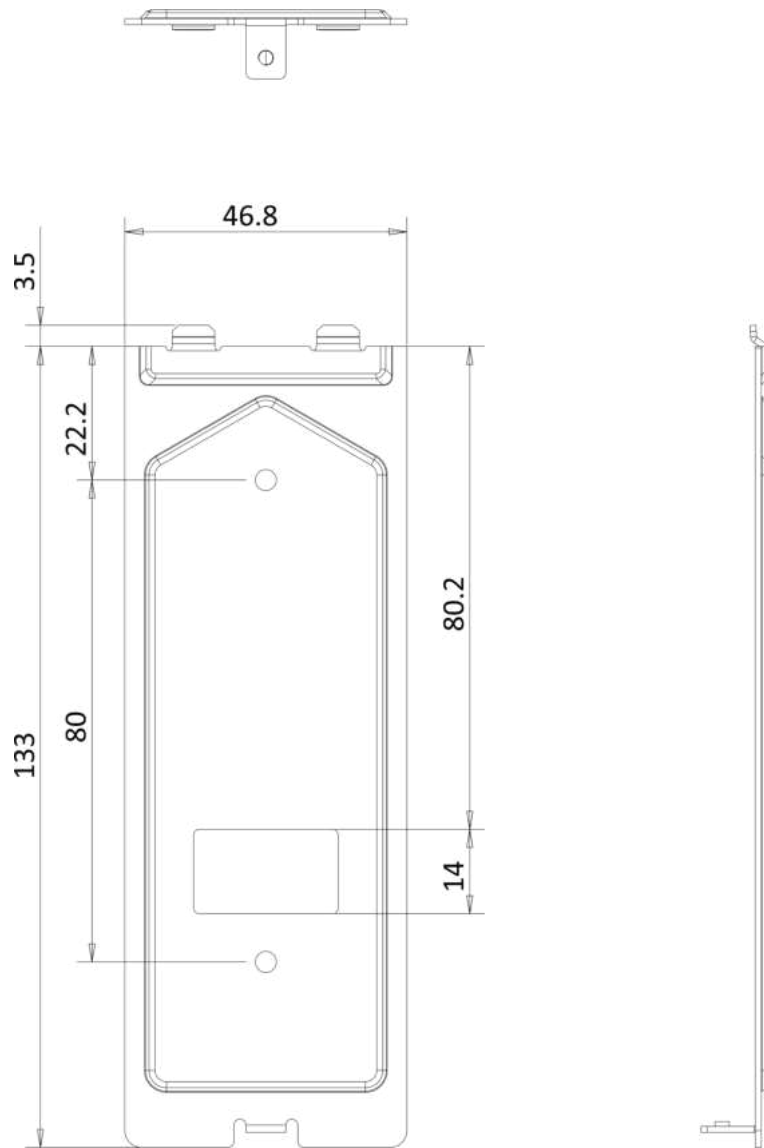

**Figure 5-4 Wall Mounting Plate**

**Steps**

1. Fix the wall mounting shield to the wall with 2 screws.
2. Hook the door station to the shield tightly by inserting the hooks of shield panel into the slots on the rear panel of the door station.
3. Secure the door station with the mounting shield with the set screw.



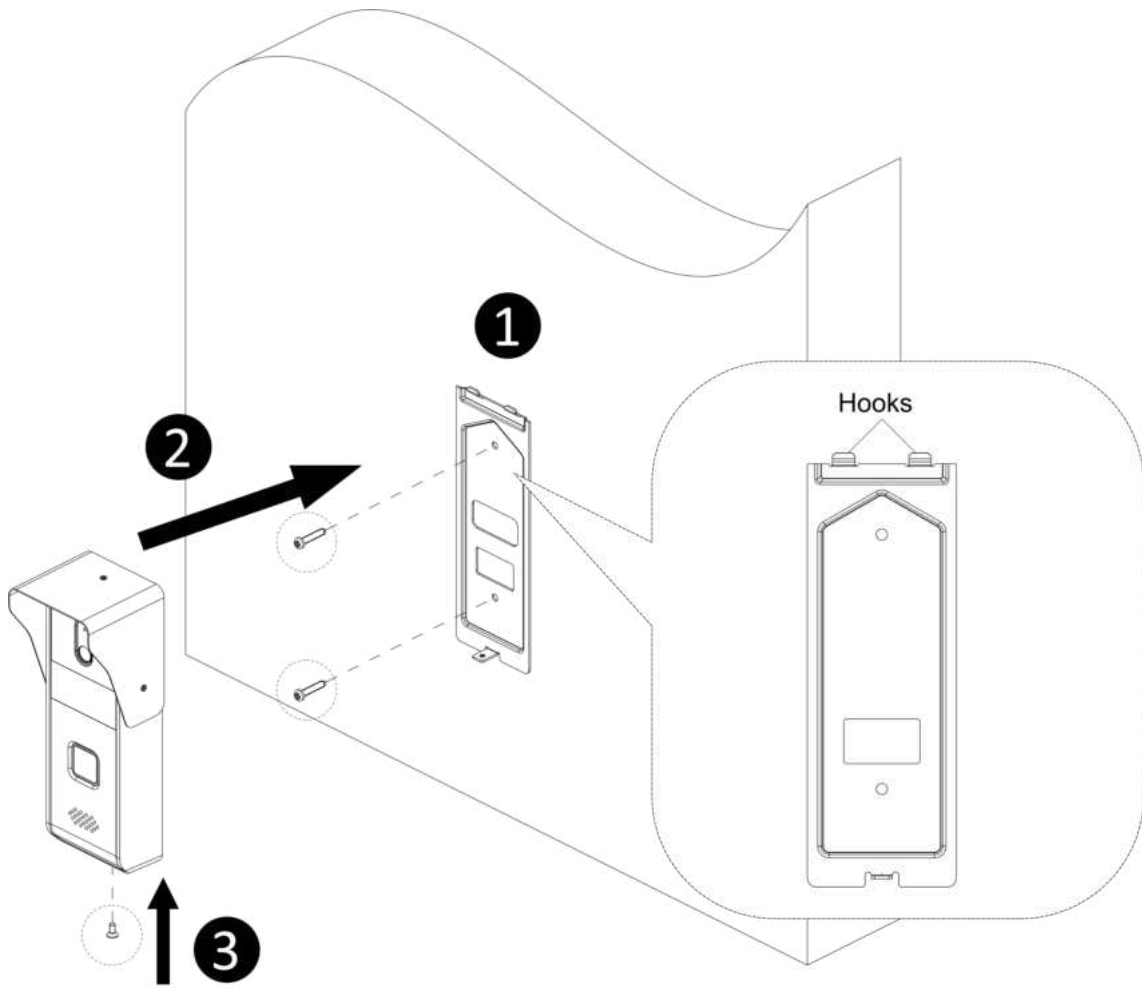

Figure 5-5 Wall Mounting

## Chapter 6 Activation

### 6.1 Activate Indoor Station

You can configure and operate the indoor station after creating a password for the device activation.

#### Steps

1. Power on the device. It will enter the activation page.

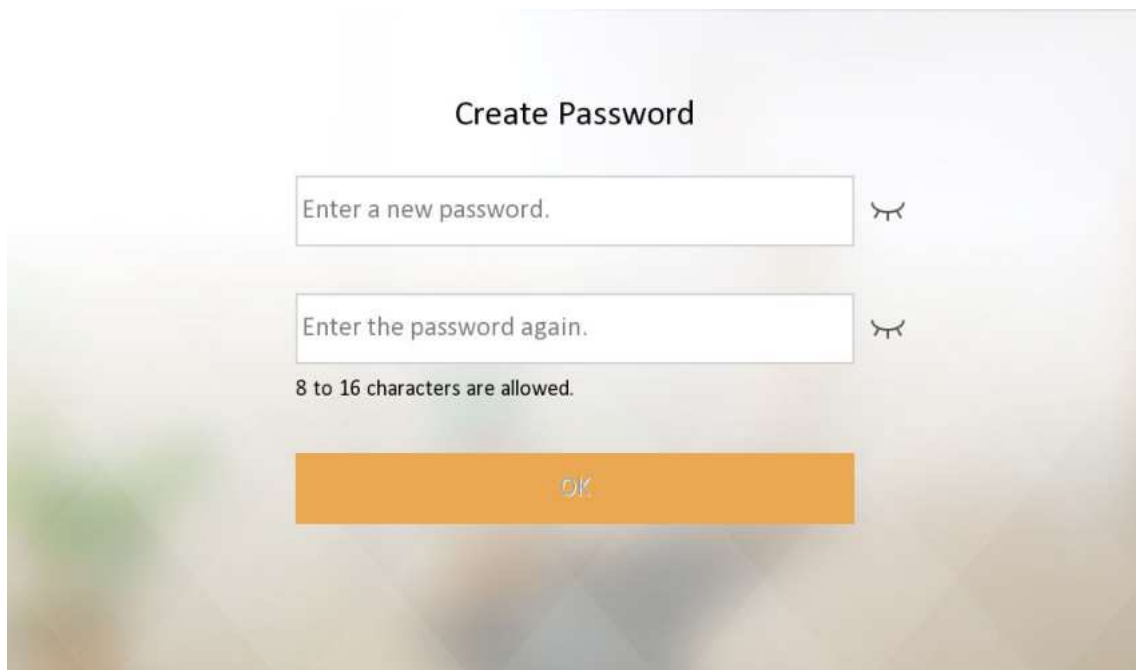



Figure 6-1 Activation Page

2. Create a password and confirm it.

---

 **Note**

You can click  to enable or disable password reveal.

3. Tap **OK** to activate the indoor station.

---

 **Note**

We highly recommend you to create a strong password of your own choosing (using a minimum of 8 characters, including at least three kinds of following categories: upper case letters, lower case letters, numbers, and special characters) in order to increase the security of your product. And we recommend you change your password regularly, especially in the high security system, changing the password monthly or weekly can better protect your product.

---

After device activation, the wizard page will pop up.

## Chapter 7 Configuration

### 7.1 Local Operation

#### 7.1.1 Quick Operation

After device activation, the wizard page will pop up. The description is for other indoor stations.

##### Steps

1. Choose language and tap **Next**.



Figure 7-1 Language Settings

2. Set password reset methods and tap **Next**.

- Bind an email address. If you forget your admin and activation password, you can change the password via the reserved email address.
- Tap **Change to Security Question** to select security questions and enter the answers. If you forget your admin and activation password, you can change the password via answering the questions.

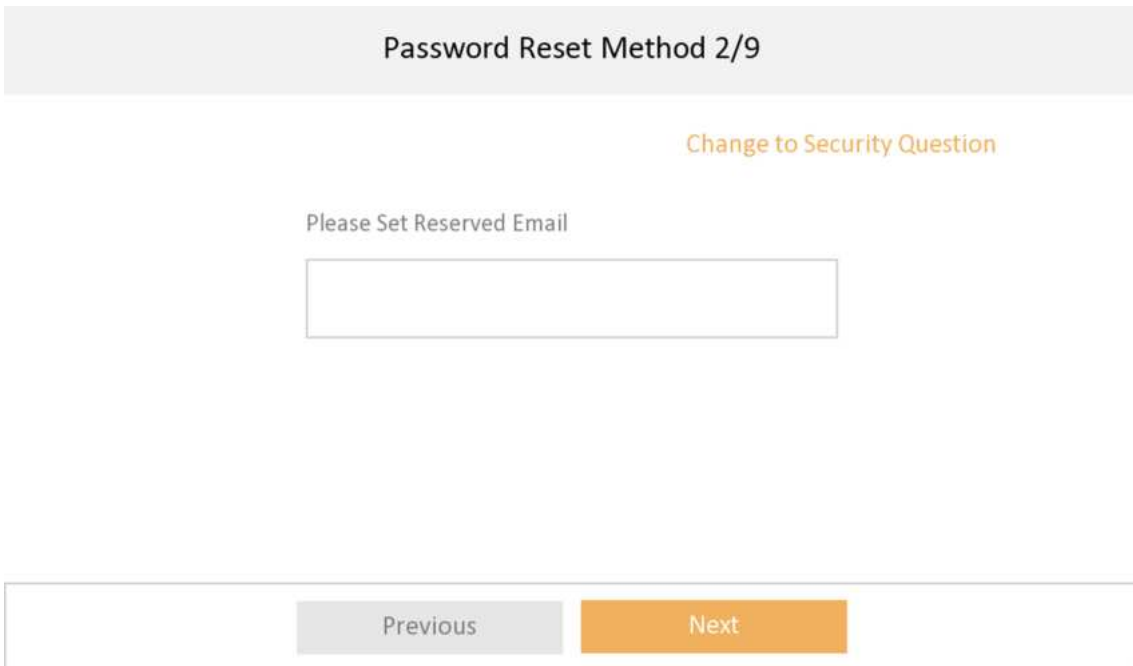

**Figure 7-2 Password Reset Methods**

3. Set network parameters and tap **Next**.
- Edit **Local IP**, **Subnet Mask** and **Gateway** parameters manually.
  - Enable **Auto Get IP address**, the device will get network parameters automatically.

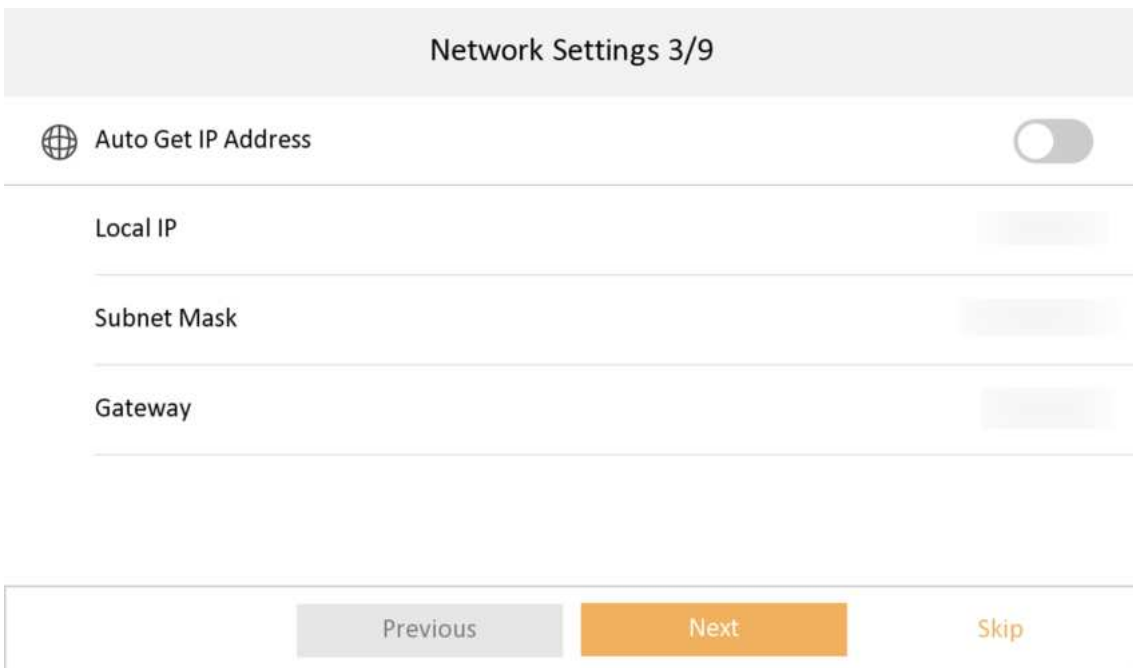

**Figure 7-3 Network Parameters**

## 4. Configure the indoor station.

- 1) Select **Device Type** as **Indoor Station** or **Indoor Extension**.
- 2) Set **Floor No.**
- 3) Set **Room No.**
- 4) Configure advanced settings. Set Community No., Building No. and Unit No.
- 5) Set **Registration Password**.
- 6) Tap **Next**.

Indoor Station Settings 4/9

Device Type Indoor Station >

Floor No 1

Room No 1

Advanced >

Registration Password Configured >

Same as the admin password.

Previous Next Skip

**Figure 7-4 Indoor Station Settings**

5. Enable the Wi-Fi function. Select a Wi-Fi from the list and enter the Wi-Fi's password to get connected. Tap **Next**.

---

### **Note**

The device should support Wi-Fi.

---

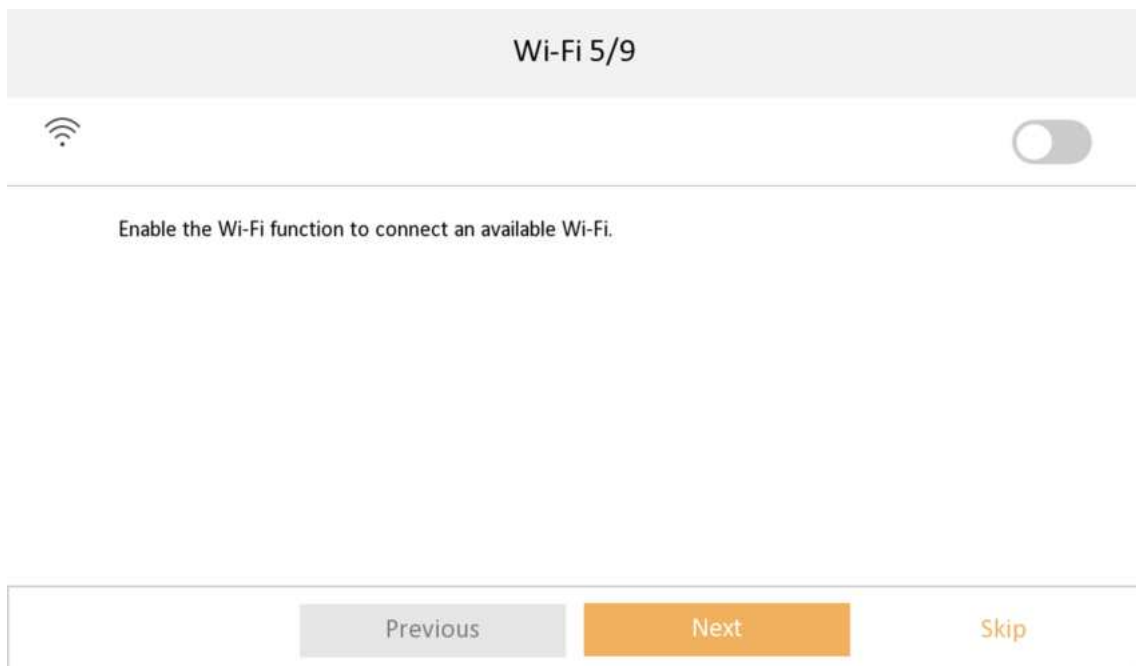

**Figure 7-5 Wi-Fi**

**6. Set time and tap **Next**.**

---

 **Note**

The time can be synchronized to door stations.

---

- 1) Select the **Time Zone**.
- 2) Tap **Date Format** and **Time Format** to set the time format.
- 3) Tap **Time** to set time manually.
- 4) Enable **DST**. Set the DST start time, end time and bias time.

Time Settings 6/9		
Time Zone	(GMT+08:00) Beijing, Urumqi, Singapore	>
Date Format	YYYY-MM-DD	>
Time Format	24-Hour Time	>
Time	2015/01/06 04:31	>
DST	Disable	>

Previous Next Skip

**Figure 7-6 Time Settings**

7. Configure the **Hik-Connect** service settings.
  - 1) Enable **Hik-Connect** service.
  - 2) Edit verification code or use the activation password by default.
  - 3) View **Hik-Connect** Server Status.
  - 4) Scan the first QR Code to download the APP of **Hik-Connect**. Scan the second QR Code to add your device to the APP. After adding the device to the APP, you can configure the device remotely.
  - 5) Tap **Next**.

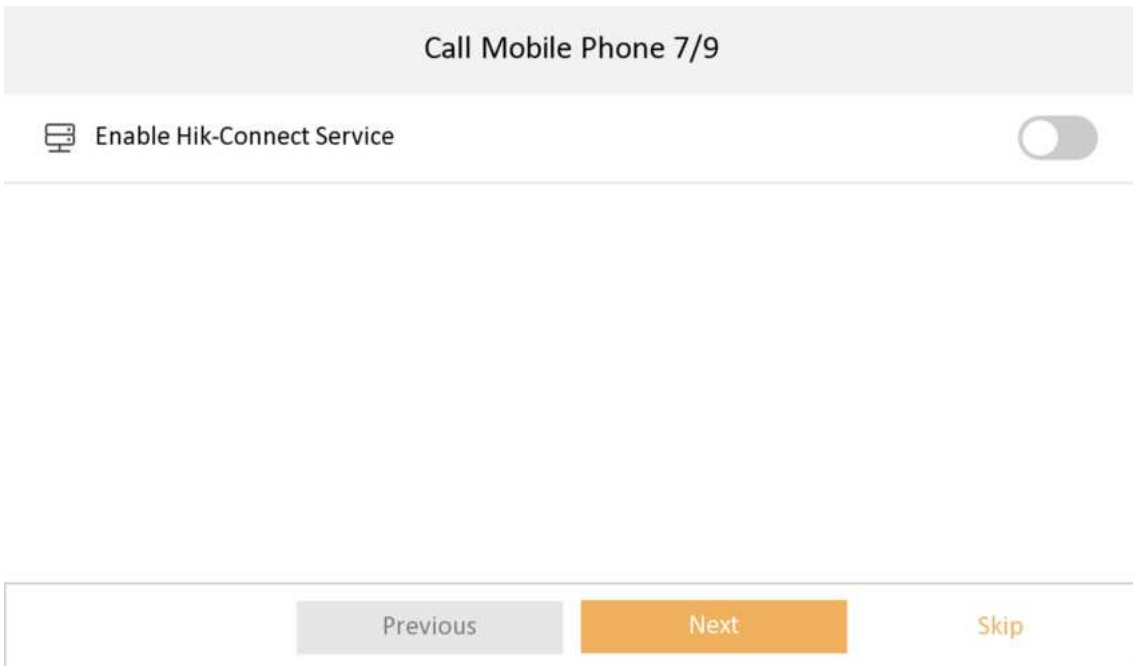

**Figure 7-7 Hik-Connect Service Settings**

8. Link related devices and tap **Next**. If the device and the indoor station are in the same LAN, the device will be displayed in the list.

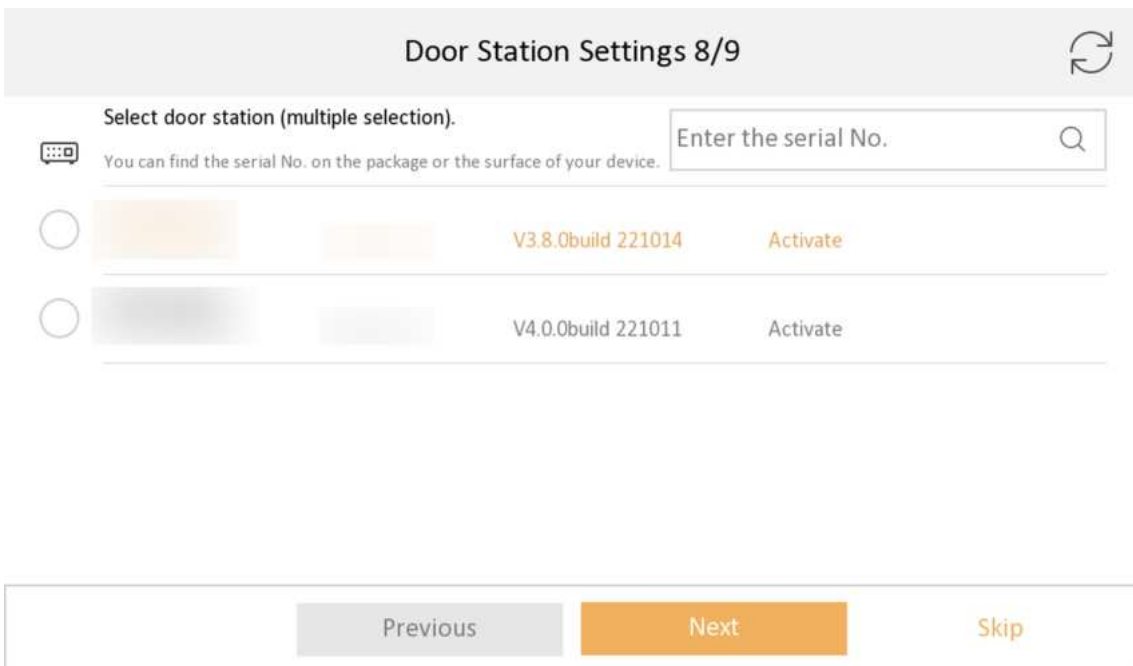

**Figure 7-8 Related Device**

- 1) Tap the door station in the list to link.



## Note

If the door station is inactive, the system will pop up the dialog to activate the door station.

- 2) Edit the network parameters of the door station manually.
- 3) Tap **Next**.

**9. Optional:** Enable **Indoor Station** and link related indoor extension devices. Tap **Finish**. If the indoor extension and the indoor station are in the same LAN, the device will be displayed in the list. Tap the device or enter the serial No. to link.

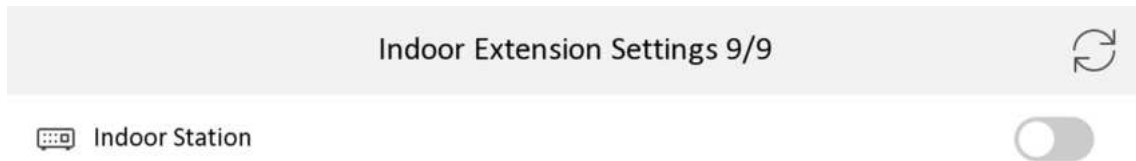

**Figure 7-9 Related Device**

- 1) Tap the indoor extension in the list to link.

## Note

If the indoor extension is inactive, the system will pop up the dialog to activate the device.

**10.** Tap **Finish** to save the settings.

## 7.1.2 Basic Settings

Basic settings is required before starting using the indoor station. It is necessary to set the indoor station network, room No., linked devices, device time display, and so on.

## Set Indoor Station Network Parameters

Network connection is mandatory for the use of the indoor station. Set the network parameters after activating the indoor station. Only when the IP address of the indoor station is in the same network segment as other devices, it can work properly in the same system.

### Steps

#### Note

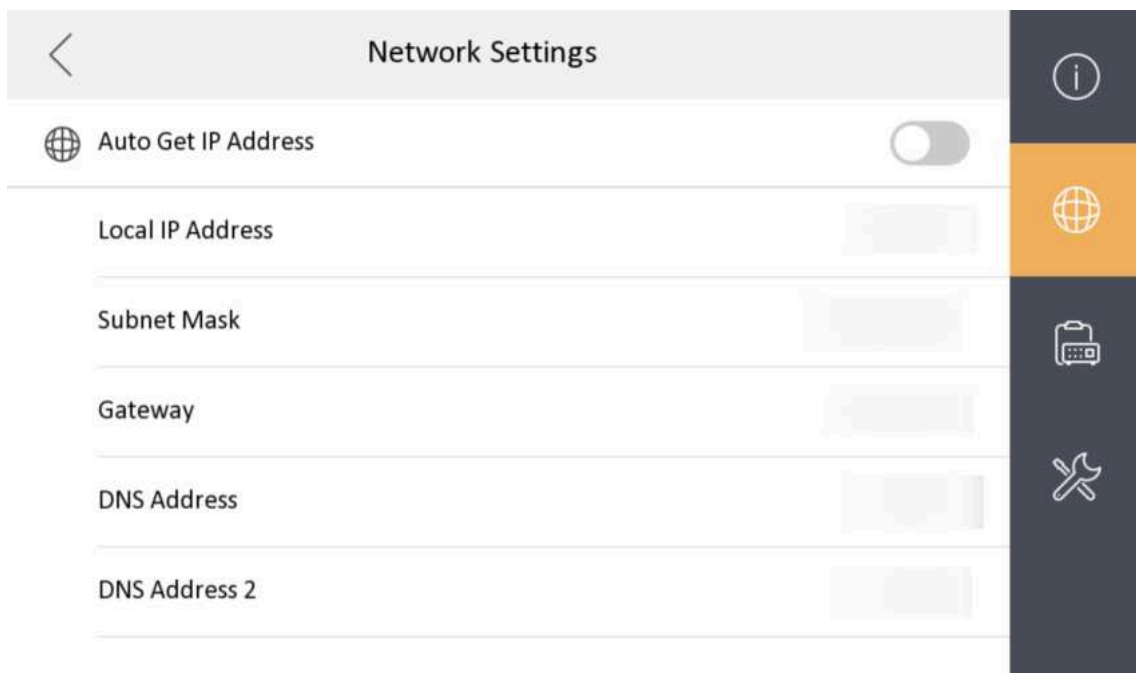

The default IP address of the indoor station is 192.0.0.64.

---



**Figure 7-10 Network Information**

Two ways are available for you to set IP address: DHCP, and set IP address manually.

1. Tap **Settings** →  → **Configuration** , and enter admin (activation) password.
2. Tap  to enter the network settings page.
3. Set the network parameters.
  - Enable **DHCP**, and the system can assign an IP address of the indoor station automatically.
  - Disable the DHCP function, and set the IP address manually. You should set the device IP address, the gateway, the DNS address.

## Connect to Wi-Fi

Set Wi-Fi connection.

Tap **Settings** → . Enable **Wi-Fi**, and the indoor station will search available Wi-Fi automatically.

### **Note**

The Wi-Fi IP can be changed.

---

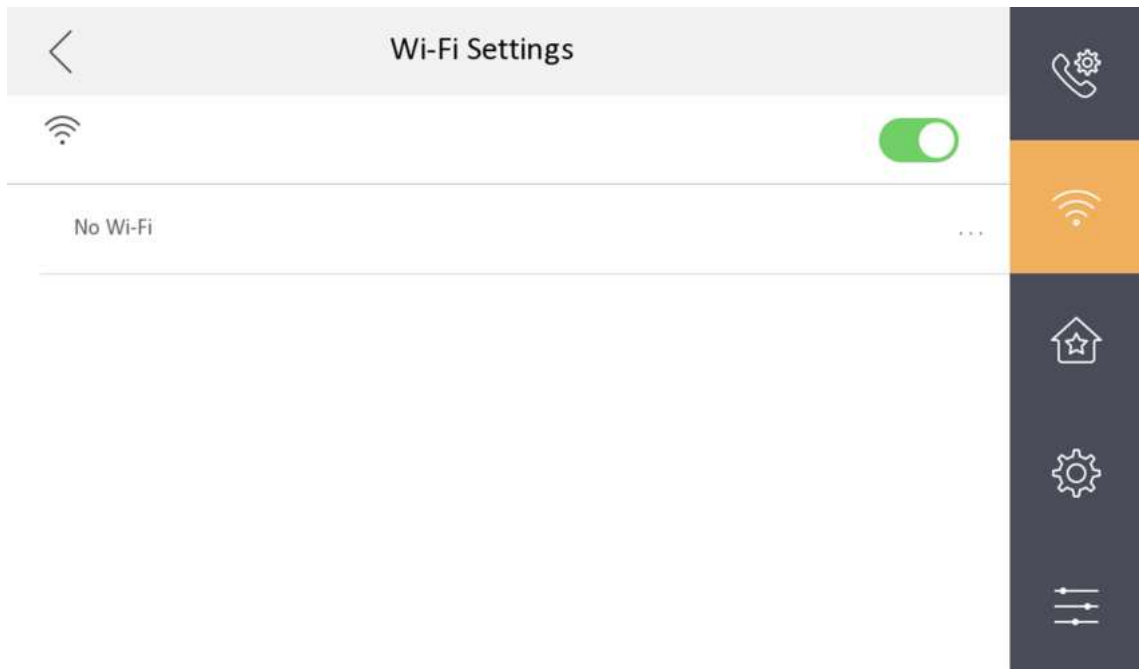

**Figure 7-11 Wi-Fi Settings**

Select an Wi-Fi and connect.

## Set Linked Device IP

Linked network parameters refers to the network parameters of devices (like door station, doorphone, main station, center, etc.), to which the indoor station is linked. Linked devices for the indoor station refers to door station, center, main station, and doorphone.

With the private SIP protocol, intercom can be realized only when all these devices are in the same network segment with the indoor station.

### Steps

---

#### **Note**

- The doorphone does not support adding with the standard SIP protocol.
  - Here take main door station network settings as example.
- 

1. Tap **Settings** →  → **Configuration** →  to enter the device management page.

 **Note**

Default admin password is the activation password.

---

2. Tap **Main Door Station** to pop up the device information dialog.

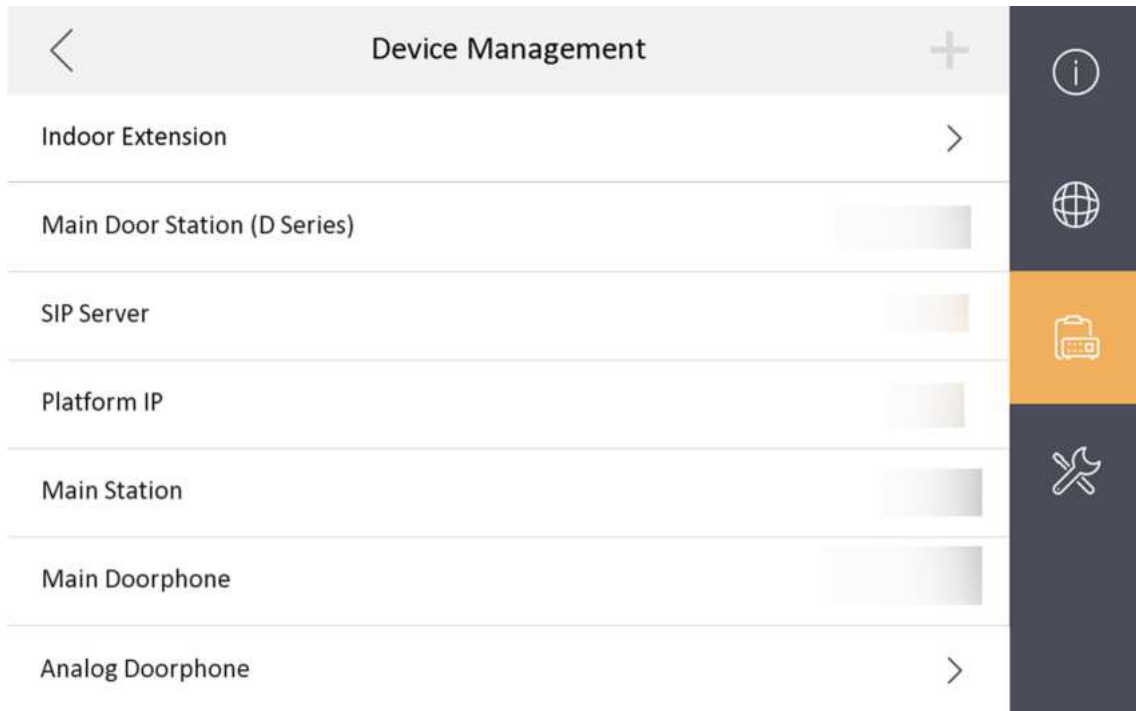

**Figure 7-13 Device Information**

3. **Set the parameters of the linked door station.** Tap  to set parameters of the door station. Select a device to link. Edit the following parameters.

**Name**

You can edit the name of the device.

**Language**

Select a language from the drop-down list for the device.

**Network**

Enable **Auto Get IP Address** and the system will assign IP address, subnet mask, and gateway automatically. Or edit the IP address, subnet mask, and gateway manually.

**Door Lock Parameters**

After wire the lock with the door station, you can set name and door opening duration according to your needs.

 **Note**

Up to 2 locks can be configured.

---

### Volume Settings

Set microphone volume and output volume.

### Call Number Settings

The call No. should be the same as the indoor station's room No. If press the call button of the door station, you can call the indoor station directly.

### Public Password

You can use the public password to open the door station related door lock. Select the public password type. Enter the old password and new password and then confirm the new password. Tap **OK** to save the settings.

### Restore to Default Settings

#### Restore All

All parameters will be restored to the factory settings. The system will reboot to take effect.

#### Device Reboot

Reboot the device.

## Set Local Information

Indoor station No. and the indoor extension No. are numbers, which can be dialed by other devices to call the indoor station and the indoor extension in an intercom system. The indoor station No., is composed of the floor No., room No., community No., building No. and unit No.

The indoor extension No. Should be a numeric from 1 to 5.

Up to 5 indoor extensions can be set for 1 indoor station.

### Steps

1. Tap **Settings** →  → **Configuration** →  to enter the indoor station No. settings page.



#### Note

Default admin password is the activation password.

---

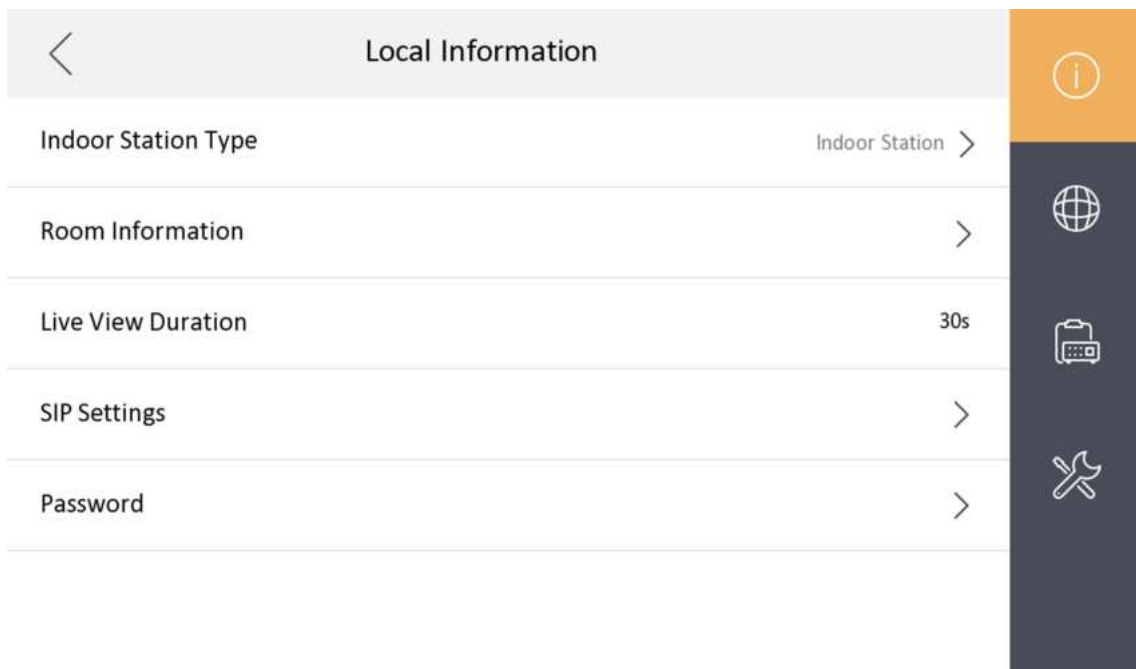

**Figure 7-14 Set Indoor Station No.**

2. Select **Indoor Station** to set the room information, live view duration, SIP parameters and password.

### Room Information

You can set room name, floor No., and room No. Tap **Advanced Settings** to set community No., building No. and unit No. if you need.

---

#### Note

- Community No., building No., and unit No. can be omitted if there is no such information.
- If there are two indoor stations that are in the same building, and should call each other, enter the the room No. directly to call.
- If there are two indoor stations that are in two buildings, and should call each other, enter the building No. and the room No. to call. For examle, call 1-405 to call room 405 in building 1.

---

### Live View Duration

You can set the duration of live view.

### SIP Settings

You can set SIP parameters. For more details, please refer to: [\*\*\*SIP Settings\*\*\*](#)

### Password Settings

You can set unlock password and duress code.

3. Select **Indoor Extension** to set the room information, live view duration, registration password and enable **SIP 1.0** according to your needs.

### Room Information

You can set room name and No. Tap **Advanced** to set the community No., building No., and unit No. if you need.

When calling the indoor station and the two devices are in the same building, you can call the room No. directly.

### Live View Duration

You can set the duration of live view.

### Registration Password

You can create a new registration password.



### Enable SIP 1.0

You can enable SIP 1.0 protocol according to your needs.

## Analog Doorphone Settings

The analog doorphone and sub doorphone share the capacity quantity. You can add maximum 1 doorphone + 14 sub doorphone + 2 analog doorphone to one indoor station. (If there is no analog doorphone, you can add 1 doorphone + 16 sub doorphone to one indoor station.)

### Steps

1. Tap **Settings** →  → **Configuration** , and enter admin (activation) password.
2. Tap  to enter the device management page.
3. Tap **Analog Doorphone**.
4. Set the name and the unlock time. Click **OK** to save the settings.

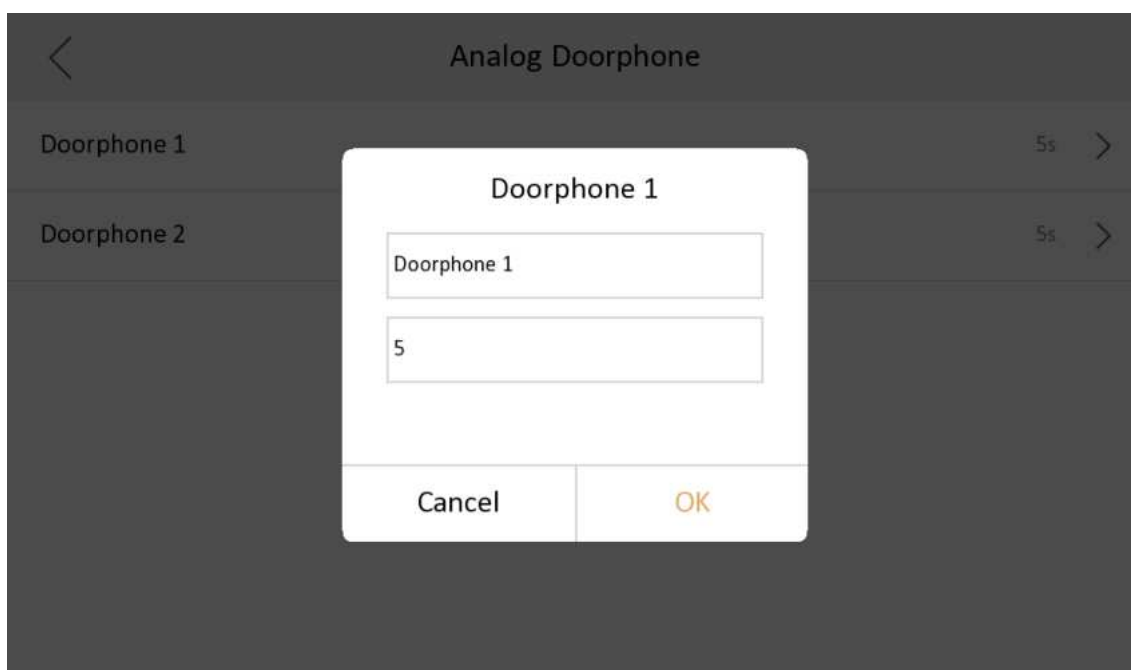

Figure 7-15 Analog Doorphone

---



### Note

The unlock time is between 1 s to 255 s.

---

## Add Camera

### Steps

1. Tap **Settings** →  → **Configuration** , and enter admin (activation) password.
2. Tap  to enter the device management page.
3. Tap + to pop up the dialog box.
4. Select a protocol to add the camera.
  - Select **HIK Protocol** and you can add the camera depended on the **HIK protocol**.  
Enter the device name, IP address, user name and the password of the camera. Edit port No. and channel No.  
Exit the page to save the settings.
  - Select **Open Network Video Interface** to add the camera.  
Enter the device name, IP address, user name and the password of the camera.  
Exit the page to save the settings.



### SIP Settings

Devices can communicate with each other via SIP protocol. You create set the SIP register password, enable standard SIP and set VOIP account.

#### Steps

1. Tap **Settings** →  → **Configuration** , and enter admin (activation) password.
2. Tap **SIP Settings** in Local Information Page.

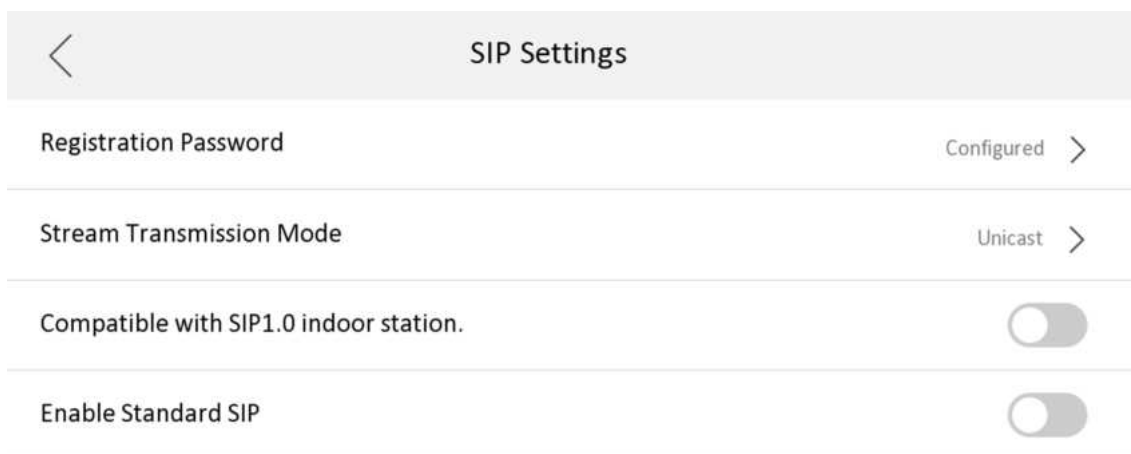

**Figure 7-16 SIP Settings**

3. Set SIP registration password.
  - 1) Tap **Registration Password**.
  - 2) Create a new SIP registration password and confirm the password.
  - 3) Tap **OK**.
4. **Optional:** Enable standard SIP.
  - 1) Slide to **Enable Standard SIP**.
  - 2) Tap **VOIP Account Settings** and configure the account information, including the user name, the phone number, the registered user name, the password, the domain, the port No., and the expiration date.

VoIP Account Settings	
User Name	Enter the user name.
Phone Number	Enter your number.
Registered Username	Enter user name.
Password	Enter the password. 
Domain	Enter the SIP server domain.
Port No.	5060
Expiration Date	60

**Figure 7-17 VOIP Account Settings**

---

 **Note**

Up to 32 characters are allowed in the user name.

---

## Zone and Alarm Settings

### Zone Settings

You can set the zone type, alarm type and delay time and other parameters of 2 zones.

#### Before You Start

Tap **Settings** →  to enable **Alarm**.

#### Steps

---

 **Note**

Arming status page and zone settings page are hidden by default. You should enable alarm function first.

---

1. Tap **Settings** →  → **Zone Settings** to enter the zone settings page.

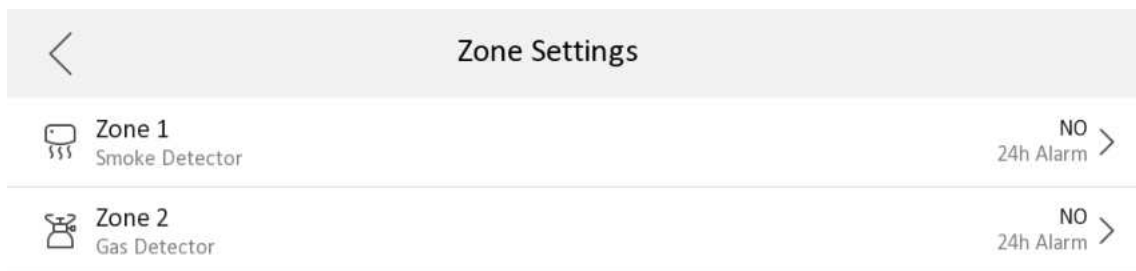

**Figure 7-18 Zone Settings**

2. Press a zone to pop up the zone editing dialogue box.
3. Set the zone type, alarm type, status of arming status, entering delay, and exiting delay.
4. Tap **OK** to save the settings.

---

 **Note**

- 2 zone types are selectable: Smoke Detector and Gas Detector.
  - For Gas Detector and Smoke Detector, the alarm type is set as default 24h alarm. The alarm type of them can not be changed.
- 

## Arming Mode Settings

4 arming modes can be configured: stay mode, away mode, sleeping mode and custom mode.

### Before You Start

Tap **Settings** →  → **Shortcut Settings** to enable Alarm.

### Steps

---

 **Note**

On the home page, the arming status function and zone settings function are hidden by default. You should enable the alarm function first.

---

1. Back to the home page, tap **Settings** →  → **Scene Settings** to enter the arming mode settings page.

2. Tap **Stay Mode**, **Away Mode**, **Sleeping Mode**, or **Custom** to enter the page.
3. Arm the selected zone.

---

### Note

- Zones are configurable on the arming mode page.
  - Smoke detector zone and gas detector zone will be triggered even if they are disabled.
- 

### 7.1.3 Password Settings

#### Modify Admin Password

You can reset admin password via reserved email or security questions.



If you only set the email address or security questions, the admin password can be reset via the method you choose by default.

If you set both the email address and security questions, you can choose either method to reset the admin password.

#### Change by Email

You can change admin password via email.

##### Before You Start

- The function of the device varies according to different models. Refers to the actual device for detailed information.
- You need to set a reserved email address at the wizard or tap **Settings** →  → **Configuration** →  → **Security Settings** → **Email Address** to set or change the reserved email address.

---

### Note

Admin password is required to enter the configuration page.

---

#### Steps

1. Tap **Settings** →  → **Configuration** .
  2. Tap **Forgot Password** at the pop up window.
  3. Change your admin password via reserved email address.
- 

### Note

Make sure the device has added to the Hik-Connect account.

---



- 1) Download Hik-Connect app.
- 2) Go to **More** → **Reset Device Password** .
- 3) Scan the QR code on the device and a verification code will be popped up.
- 4) Enter the verification code on the device page.

- 5) Tap **OK**.
4. Create a new password and confirm it.
5. Tap **OK**.

### Change by Security Question

You can change admin password via security questions.

#### Before You Start

You need to security questions at the wizard or tap **Settings** →  → **Configuration** →  → **Security Settings** → **Security Question** to set or change the answers to the questions.



#### Note

Admin password is required to enter the configuration page.

---

#### Steps

1. Tap **Settings** →  → **Configuration** .
2. Tap **Forgot Password** at the pop up window.
3. Answer the security questions.
4. Tap **OK**.

### Modify Arm/Disarm Password

You can create and edit the arm/disarm password of the indoor station.



#### Steps

1. Tap **Settings** →  → **Password** to enter the settings page.
2. Tap **Arm/Disarm Password**. Create the indoor station's arm/disarm password. You should enter the arm/disarm password to enable or disable the function.
3. When you slide to disable **Scene Password**, there is no needs to enter password during scene mode switching.

### Modify Unlock/Duress Code

You can create and edit the duress code and unlock password of the indoor station.

#### Steps

1. Tap **Settings** →  → **Configuration** , and enter admin (activation) password.
2. Tap  → **Password** to enter the password settings page.
3. Tap **Unlock Password** or **Duress Code** to pop up the password settings dialog box.

#### Unlock Password

Create the indoor station's unlock password. If the device has connected to a lock, enter the password to unlock.

### Duress Code

When you are hijacked and forced to open the door, you can enter the duress code. An alarm will be triggered to notify the management center secretly.



#### Note

The duress code and the unlock password cannot be the same.



---

4. Create a new password and confirm it.
5. Tap **OK** to save the settings.

### Modify SIP Password

You can change the SIP password.

#### Steps

1. Tap **Settings** →  → **Configuration** , and enter admin (activation) password.
2. Tap  → **SIP Settings** to enter the page.
3. Tap **Registration Password** to pop up the SIP registration password settings dialog box.
4. Create a new password and confirm it.
5. Tap **OK** to save the settings.

### 7.1.4 Synchronize Time

#### Steps

1. Tap **Settings** →  → **Time and Date** to enter the time synchronization page.
2. Tap **Date Format** and **Time Format** to set the time format.
3. **Optional:** Tap **Time** to set time manually.
4. Tap **Sync Time**.



**Figure 7-19 Time Synchronization**

- 1) Select the **Time Zone**.
- 2) Enable **Enable NTP**.
- 3) Set the synchronizing interval, enter the IP address/domain of NTP server and port No.

---

 **Note**

- The default unit of synchronizing interval is minute.
  - The time zone can be configured as well if the NTP is not enabled.
- 

### 7.1.5 Sound Settings

Set the ringtone sound, the volume, and the auto answer.

### Call Settings

You can set the ringtone, ring duration, call forwarding time on call settings page.

#### Steps

1. Tap **Settings** →  to enter the call settings page.

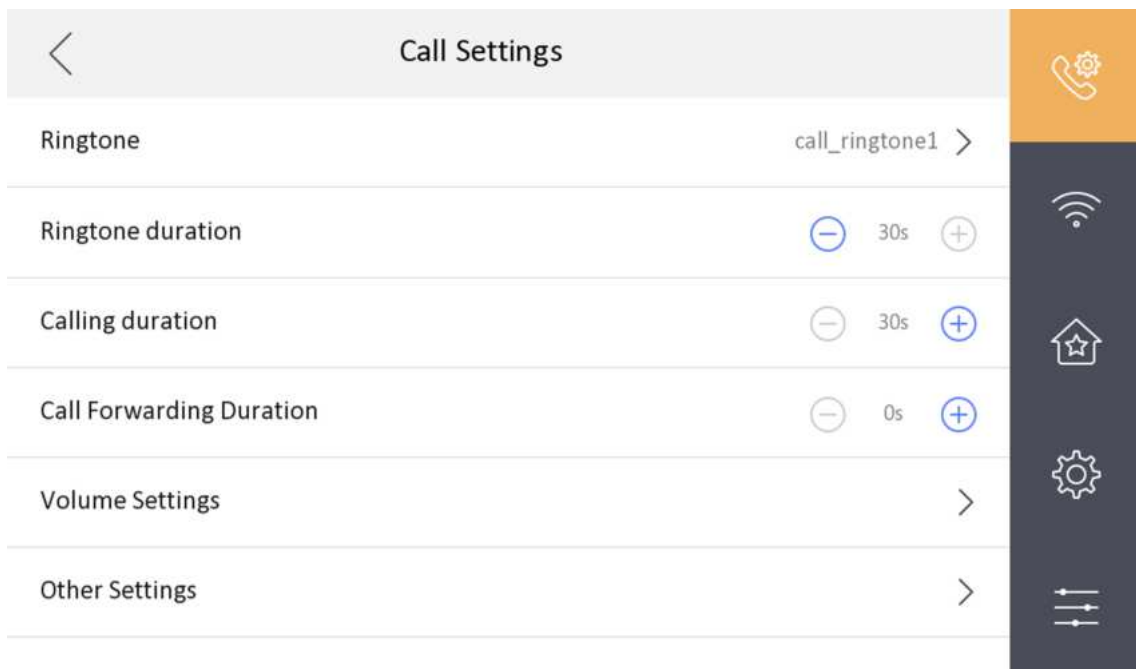

Figure 7-20 Call Settings

2. Set corresponding parameters.

**Ringtone**

There are 3 ringtones by default, and you can custom and import at most 4 ringtones via Batch Configuration Tool or iVMS-4200 Client Software.

Ringtone Duration: The maximum duration of indoor station when it is called without being accepted. Ringtone duration ranges from 30 s to 60 s.

**Calling Duration**

The call will end automatically when the actual calling duration is longer than the configured one. Calling duration ranges from 30 s to 60 s.

**Call Forwarding Duration**

The ring duration limit beyond which the call is automatically forwarded to the mobile phone designated by the resident. Call forwarding ranges from 0 s to 20 s.

**Other Settings**

You can set the Do Not Disturb and Auto-answer functions.

**Auto-answer**

Enable **Auto-answer**. After enabling, the call from door station/villa door station will be answered by the indoor station automatically. The caller from door station/villa door station can leave voice messages. After the message is left, you can check it from **Message** on the main page of the device.





Figure 7-21 Main Page

---

### Note

Before enabling **Auto-answer**, the function of **Leave Message** needs to be enabled. Tap **Settings** →  → to enter the shortcut settings page. Enable **Leave Message** and go back to calling settings page to enable **Auto-answer**.

---

### Do Not Disturb Device

Select **All** and all devices will not disturb this device. Select **Indoor Station** and all indoor station will not disturb this device.

### Do Not Disturb

Set the do not disturb schedule. Select **Close** and the do not disturb function will not be enabled. Select **All Day** and this device will not be disturbed all day. Select **Schedule** and you can set the do not disturb time duration. Within the configured time, this device will not be disturbed.

---

### Note

Indoor extension does not support the ring duration settings, call forwarding settings, or auto-answer function.

---

## Volume Settings

Set the microphone volume, prompt sound volume, call volume, and enable touch sound.

### Steps

1. Tap **Settings** →  → **Volume Settings** to enter the volume settings page.

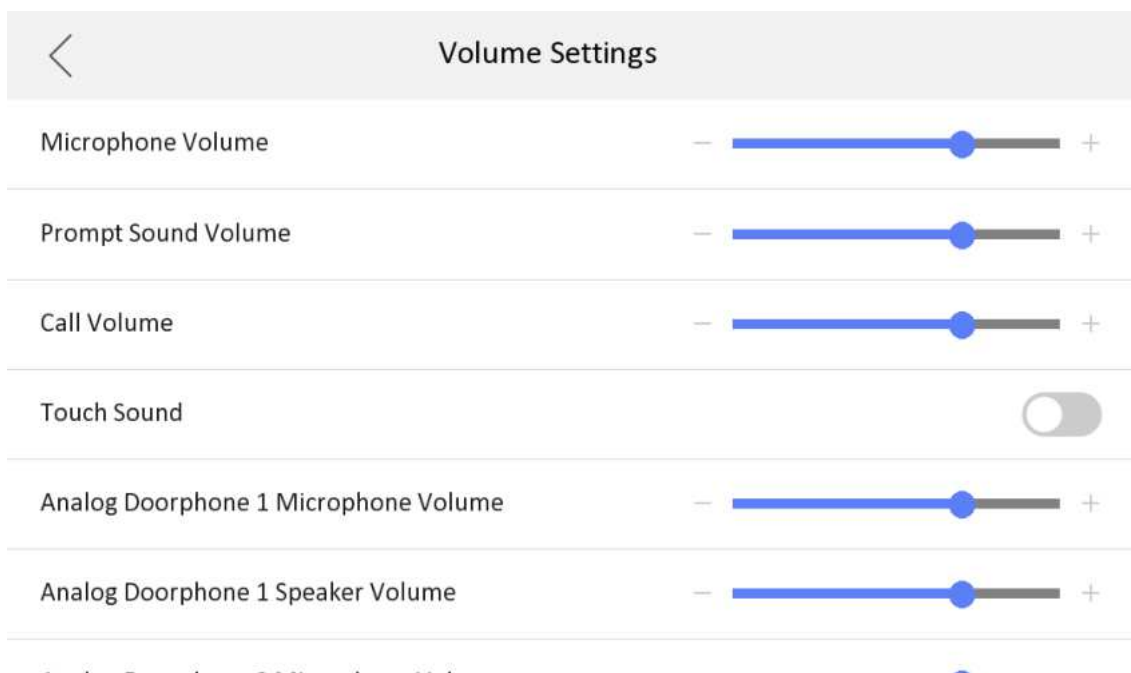

**Figure 7-22 Volume Settings Page**

2. Set the microphone volume, prompt sound volume, and the call volume of the indoor station. Set the microphone volume and speaker volume for analog doorphone.
3. **Optional:** Enable **Touch Sound** to turn on the sound when you touch device screen.



### 7.1.6 Link to the Mobile Client

#### Before You Start



The function of the device varies according to different models. Refers to the actual device for detailed information.

#### Steps

1. Tap **Settings** →  → **Configuration** →  → **Hik-Connect Service Settings** to enter the settings page.



Admin password is required to enter the configuration page.

2. Enable **Enable Hik-Connect Service**.

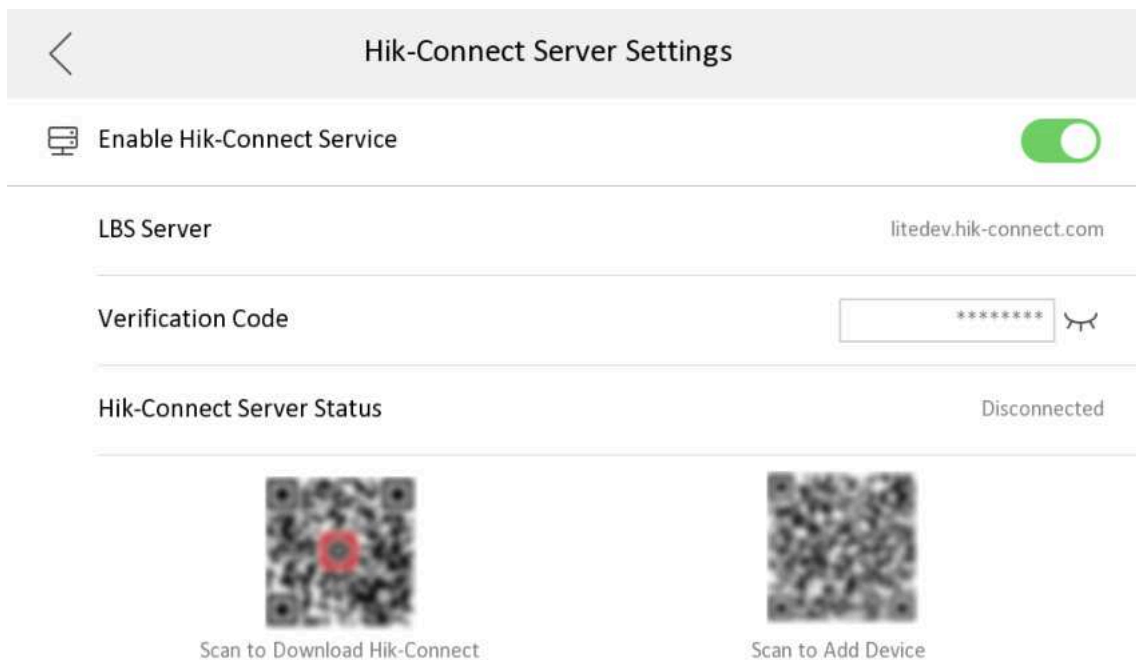

**Figure 7-23 Enable Guarding Vision Service**

**3. Edit LBS server and Verification Code.**

 **Note**

Verification code is used to add the device to mobile client.

**4. Optional:** Scan the QR code on the screen.

 **Note**

- Scan the left QR code on the screen to access Hik-Connect.
- Scan the right QR code on the screen to add the device to the mobile client.

## 7.1.7 System Settings

### General Settings

You can format or install TF card, clean the screen, set system language and adjust the screen brightness on this page.

Tap **Settings** →  to enter the general settings page.

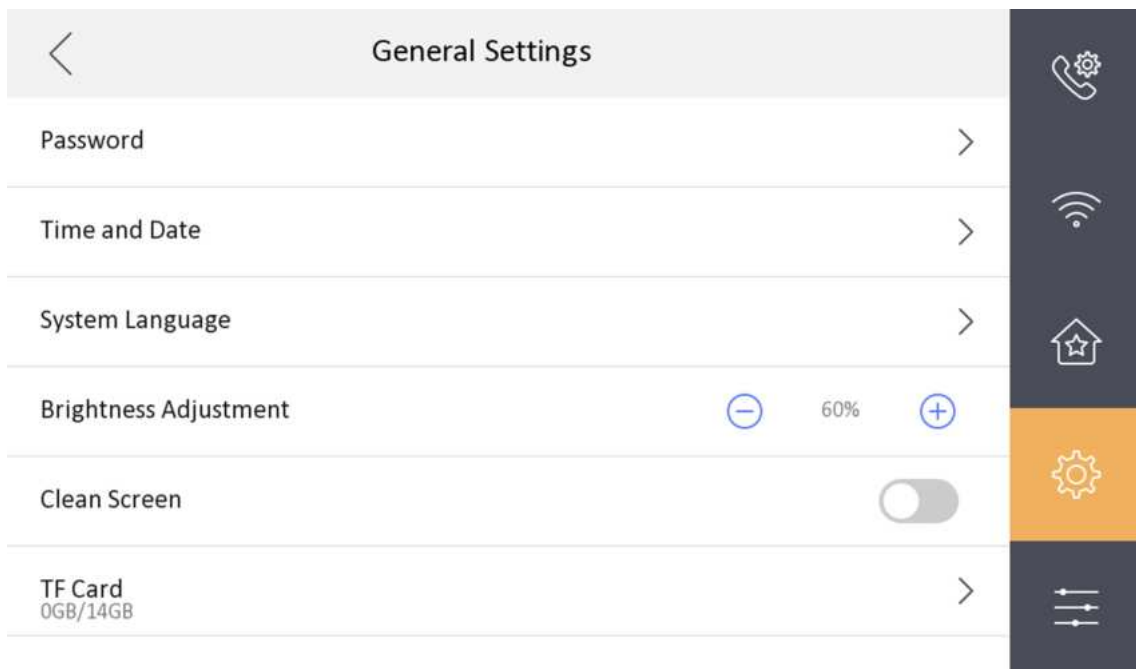

**Figure 7-24 General Settings Page**

## Password

You can manage your arm/disarm password and scene password. For details, see [\*\*\*Modify Arm/Disarm Password\*\*\*](#)

## Time and Date

You can set the displayed time and date format, current time. You can also tap **Sync Time** and enable NTP to synchronize the device time.

---

### Note

- Make sure your device is connected with the network or the NTP function will not available.
  - For details, see [\*\*\*Synchronize Time\*\*\*](#) .
- 

## System Language

Tap **System Language** to change the system language.

---

### Note

The indoor station supports 11 languages.

---

## Brightness Adjustment

Tap + or - to adjust the screen brightness.

## Clean Screen

Enable **Clear Screen** and the screen will be locked for 30s. And you can clear the screen within the time duration.

---

## Note

- After enabling Clear Screen function, press and hold the Unlock key to exit the clear screen mode.
  - The device without unlock key will exit the clear screen mode automatically when the time is out.
- 

## TF Card

Tap **TF Card** to view the TF card and you can also format the TF card.

## Maintenance

You can restore the device, upgrade system, unlink app account, set wizard, and configure security settings on the system maintenance page.

Tap **Settings** →  → **Configuration** →  to enter the system maintenance page.

---

## Note

Admin password is required to enter the configuration page.

---

### Restore Default Settings

Tap **Restore Default Settings** to restore the default settings and reboot the system.

### Restore All

Tap **Restore All** to restore all parameters and reboot the system.

### Upgrade

Tap **Upgrade** to get the upgrade package online.

### Unlink APP Account

Tap **Unlink APP Account** to unlink the Hik-Connect account from the platform.

---

## Note

The function of the device varies according to different models. Refers to the actual device for detailed information.

---

## Wizard

Tap **Wizard** and set the language, password reset method, network parameters, indoor station parameters, platform service, and related device. For details, refer to **Quick Operation** .

## Security Settings

Tap **Security Settings** and set the email address or security questions for password reset.

## Preference

You can configure zone settings, scene settings and shortcut settings on the preference page.

Tap **Settings** →  to enter the preference page.

### Zone Settings

---



Only when enable **Alarm** in the shortcut settings, can the **Zone Settings** displayed on the Preference page.

---

Set the zone parameters. For details, see [Zone Settings](#) .

### Scene Settings

---



Only when enable **Alarm** in the shortcut settings, can the **Scene Settings** displayed on the Preference page.

---

Set the scene parameters, including the stay mode, the away mode, the sleeping mode, or customize the scene. For details, see [Arming Mode Settings](#) .

### Shortcut Settings

Enable call elevator, alarm, call management center, leave message or snapshot and the icon will be displayed on the home page.

You can set the leave message time and snapshot time if the two functions are enabled.

## 7.1.8 Output Settings

You can set and control the connected output devices via the output settings page. You can change the relay' name, and open duration. You can also set to display the relay button on the main page or not.

### Steps

1. Tap **Settings** →  → **Output Settings** .
- 



- Supports up to 2 relays.
  - If no relays displayed on the page, the device may not support the function.
- 

2. Select a relay and set the parameters.

#### Name

You can change the relay's name.

---

### **Note**

1 to 32 characters are allowed. Supports uppercase letters, lowercase letters, numerics, and special characters.

---

### **Remain Open**

Enable the function, the relay remains open.

Disabled the function, and you can set the remain open duration.

---

### **Note**

- By default, the function is disabled.
  - 1 to 180 s are available to set.
- 

### **Hide on Main Page**

Enable the function and the relay button will be displayed on the main page. You can control the relay status manually on the main page.

Disabled the function and the relay button will no be displayed on the main page.

## **7.1.9 Device Information**

View the device information, including the version, model, serial No. and open source disclaimer.

### **Steps**

1. Tap **Settings** →  → **Device Information** to enter the Device Information page.
2. View the device version, model, and serial No.
3. **Optional:** Tap **Open Source Disclaimer** to view the OSS statement.

## Chapter 8 Operation

### 8.1 Local Operation

#### 8.1.1 Call Settings

##### Add Contact

###### Steps

1. Tap **Call** →  to enter the contact list page.

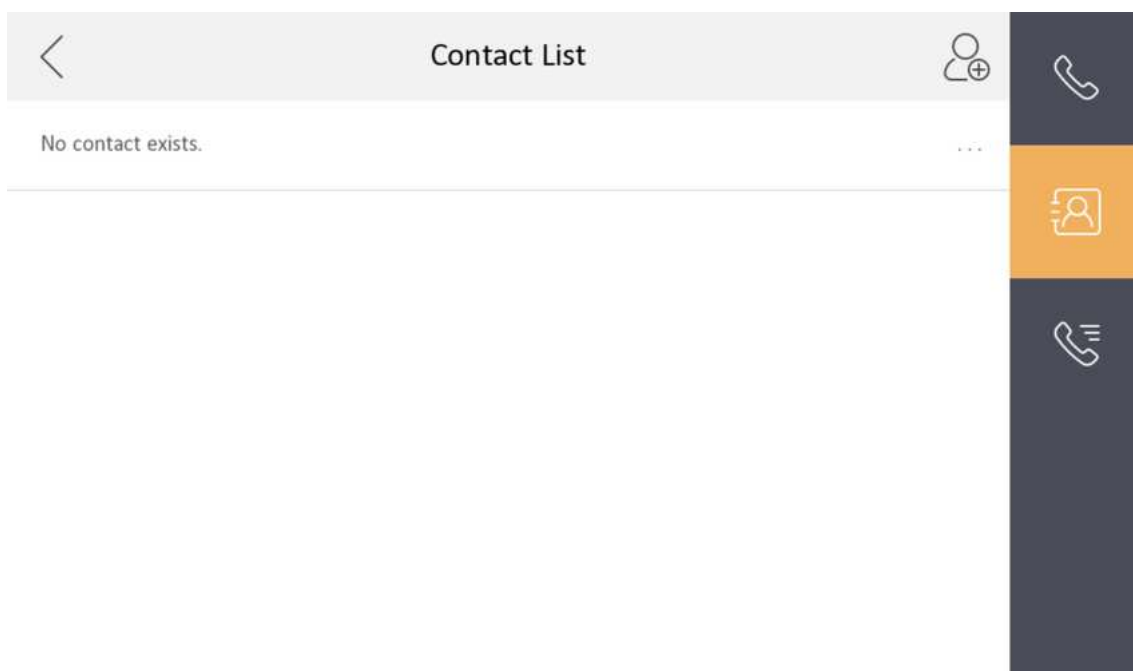

**Figure 8-1 Contact List**

2. Tap  to pop up the contact adding dialog.
3. Enter the contact name and the room No.
4. Tap **OK** to save the settings.

---

###### **Note**

Up to 200 contacts can be added.

---



## Call Resident

### Steps

1. Tap **Call** →  to enter the residents calling page.

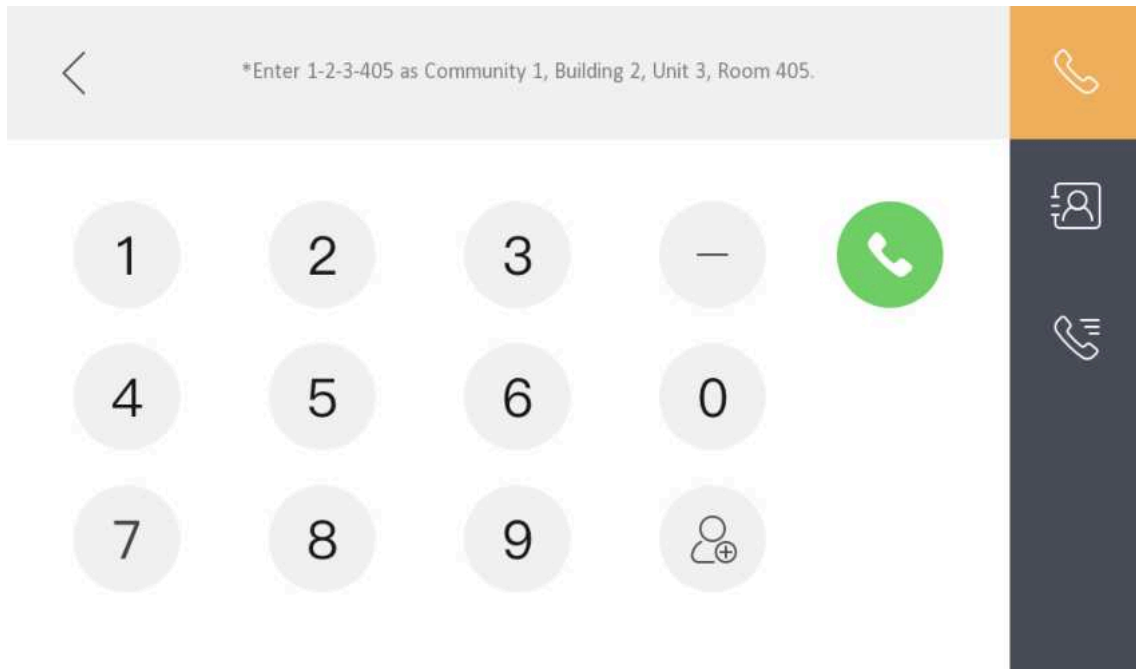

**Figure 8-2 Call Resident**

2. Enter the calling number.

The calling number format should be x-x-x-xxx. For example, the calling number of Community 1, Building 2, Unit 3, and Room 405 is 1-2-3-405.

---

 **Note**

The community No. can be omitted.

3. Tap the call button to start an audiovisual call.

## Call Indoor Extension/Indoor Station

If you install indoor station and indoor extensions at home, you can call the indoor extension via your indoor station, and vice versa.

Enter **【0-indoor extension No.】** on the indoor station to start calling.

Enter **【0-0】** to call the indoor station from the indoor extension.

## Receive Call

The indoor station and indoor extension can receive calls from the analog doorphone, the door station, the main station or iVMS-4200 Client.

On the call from door station page, there are 2 unlock buttons: Unlock 1, and Unlock 2. When you tap **Unlock 1**, the building gate will open by default, and when you tap **Unlock 2**, the door connected to the door station with the secure control door unit will open.

Tap the capture button to capture and save the live view picture when speaking with the door station.

On the call from the analog doorphone page, you can tap the unlock button to open the connected door lock and tap the capture button to capture and save the live view pictures.

---

### Note

- The indoor extension can connect to indoor station with network cables. After connecting, the indoor extension can receive calls from devices that linked to the indoor station.
  - The indoor extension can link to analog doorphones independently and receive calls from linked doorphones.
- 

## View Call Logs

### Steps

1. Tap **Call** →  to enter the call log page.

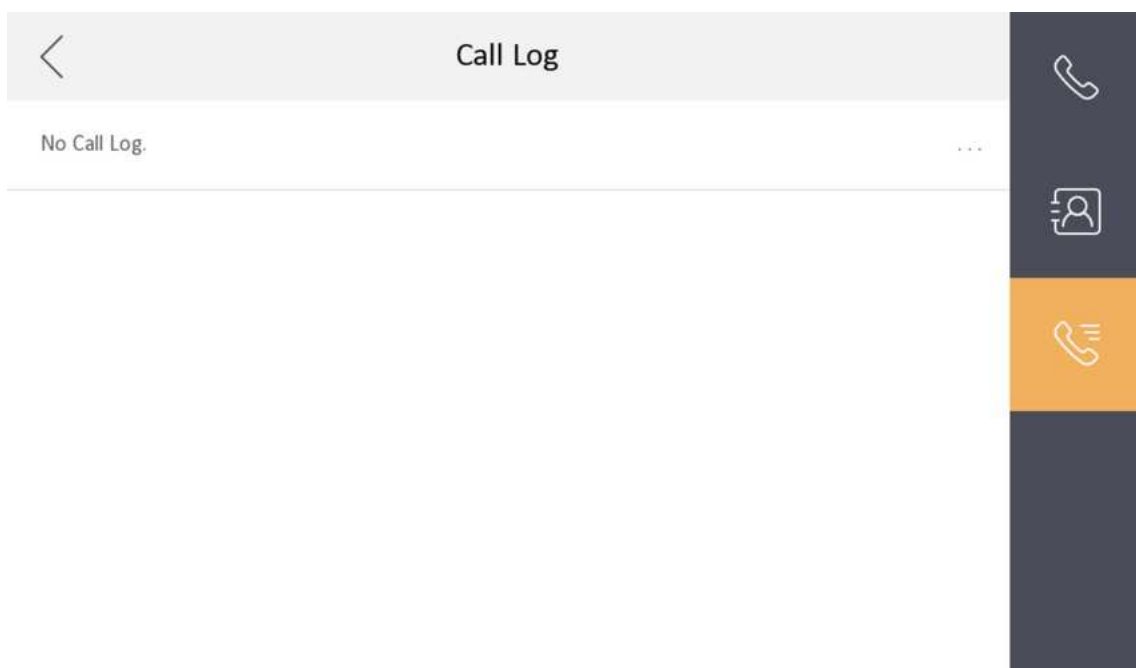

Figure 8-3 Call Logs

2. Tap a piece of call logs in the list to call back.

---

### Note

- The indoor station saves call logs from analog doorphones, door stations, outer door stations, management center and other indoor stations.
  - Hold a piece of call logs to open the call logs handling menu. Tap **Delete** to delete the piece of call logs. Tap **Clear** to delete all pieces of call logs.
- 

### 8.1.2 Leave Message

You can set leave message, and view the messages.

Tap **Settings** →  → **Shortcut Settings** , and enable **Leave Message**.

Set **Leave Message Time** as **1 day**, **7 days** or **30 days**.

Tap **Message** →  to view the visitor messages.

### 8.1.3 Live View

On the live view page, you can view the live video of added door station and network camera.

#### Steps

---

### Note

- Make sure the network camera or door station is well-connected.
  - Make sure the indoor extension and the indoor station are well-connected.
  - If the main indoor station uses V2.2.4 or later firmware, and the indoor extension uses firmware earlier than V2.2.4, there will be some restriction:
    - a. Indoor extension can only live view doorphone 1 and cannot live view doorphone 2. So it is better to use both indoor station and extension with same model and firmware.
    - b. Indoor extension can only unlock doorphone1 and intercom function cannot be enabled in live view page.
    - c. Analog doorphone and indoor extension cannot be live viewed in Hik-Connect App at the same time.
    - d. When calling from analog doorphone, the main indoor station will show the real number, while the indoor extension will only show **main doorphone** in call log (in order to be compatible with the old version indoor extension) .
    - e. The indoor extension supports switching IPC when video intercoming with door stations but the main indoor station does not support. (Unblockable for compatibility with old versions.)
- 

1. Tap **Live View** to enter the live view page.

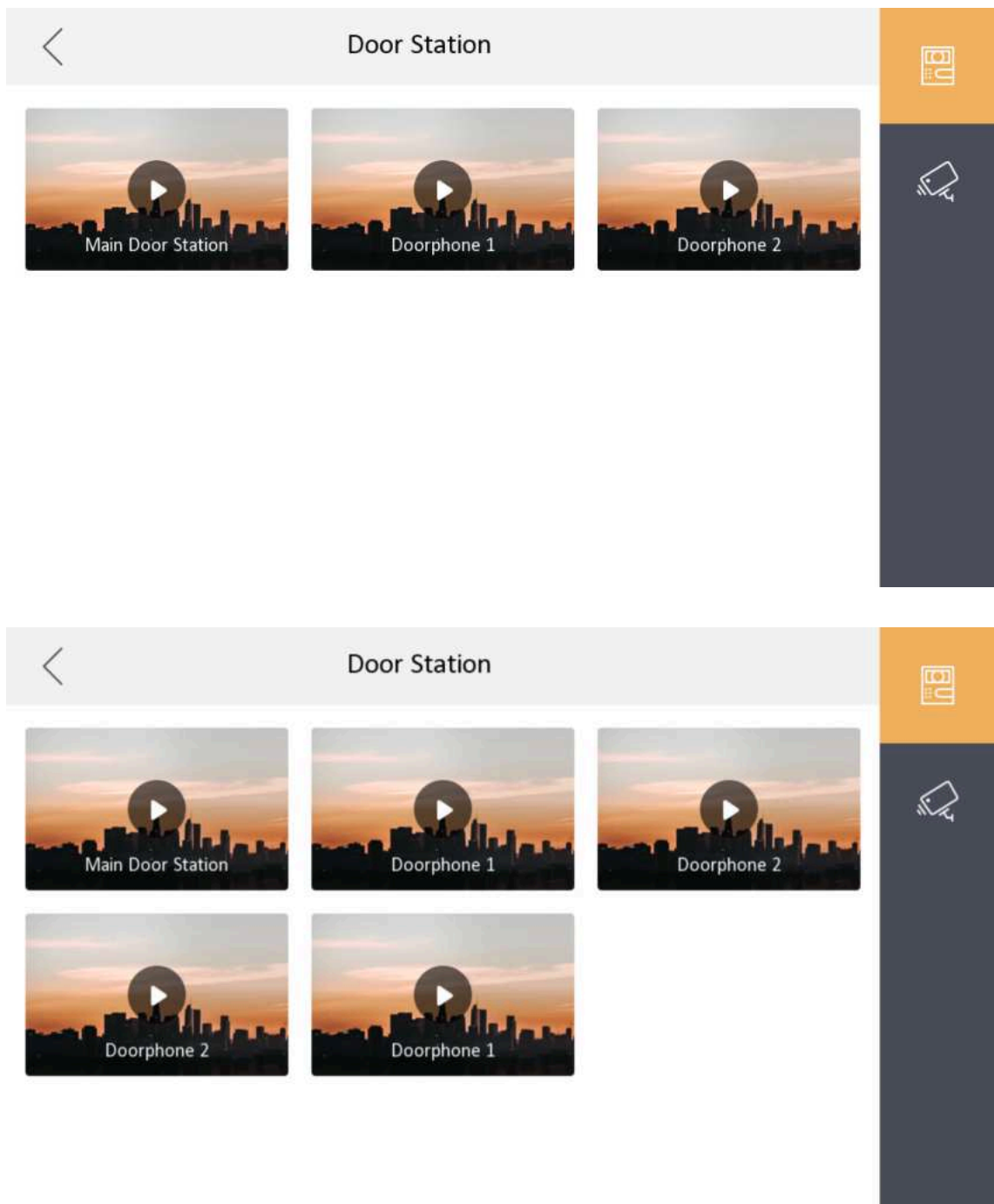



Figure 8-4 Live View

---

### Note

- The indoor extension can connect to indoor station with network cables. After connecting, the indoor extension can view related devices that linked to the indoor station.
- The indoor extension can link to analog doorphones independently and view linked doorphones.

---

2. Tap  to enter the live view page of door station.

---

### Note

- On the Call from Door Station page, there are 2 unlock buttons: Unlock 1, and Unlock 2. When you tap **Unlock 1**, the building gate will open by default. When you tap **Unlock 2**, the door station connected door will open.
- On the **Call from Door Station** page, there are 1 capture button. You can tap the button to capture the picture via door station.
- On the Call from Analog Doorphone page, there are 1 unlock button and 1 capture button. You can tap the buttons to unlock the connected door or capture pictures.

---

3. Tap  to enter the live view page of network cameras.

### 8.1.4 Arm/Disarm

The indoor station has four kinds of scene modes: sleeping mode, stay mode, away mode, and custom mode. You can arm or disarm your room in each scene mode manually. The selected scene mode will be displayed on the main page of the indoor station.

---

### Note

You should create an Arm/Disarm Password first.

---

### Arm Room

#### Steps

---

### Note

Only when the Alarm shortcut function is enabled, should the call center button be displayed. For details, see the configuration guide.

---

1. Tap  on the home page to enter the scene page.

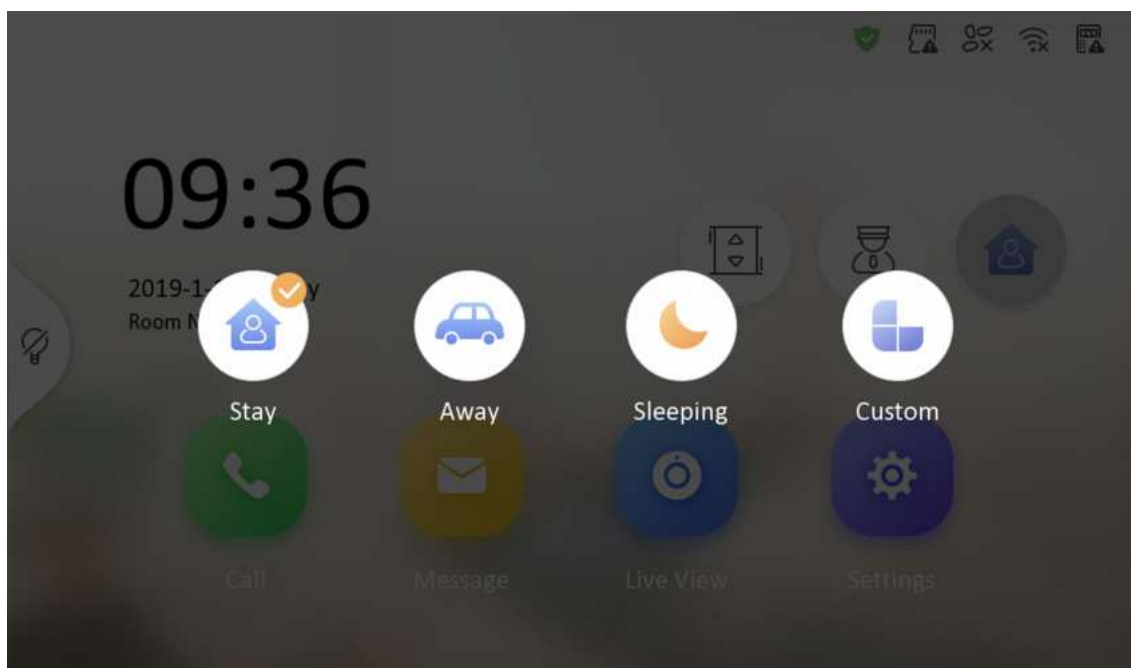

**Figure 8-5 Arm Settings page**

2. Select **Stay**, **Away**, **Sleeping** or **Custom**.
3. Enter the arm/disarm password to enable the scene.

---

 **Note**

You can set the arm/disarm password in the general settings. For details, see the configuration guide.

4. Tap **OK**.

---

 **Note**

You can also tap  → **One-Push to Arm** at the upper right corner of the home page to enable the scene.

---

## Disarm Room

### Steps

1. Tap  → **One-Push to Disarm** at the upper-right corner of the home page to disarm.

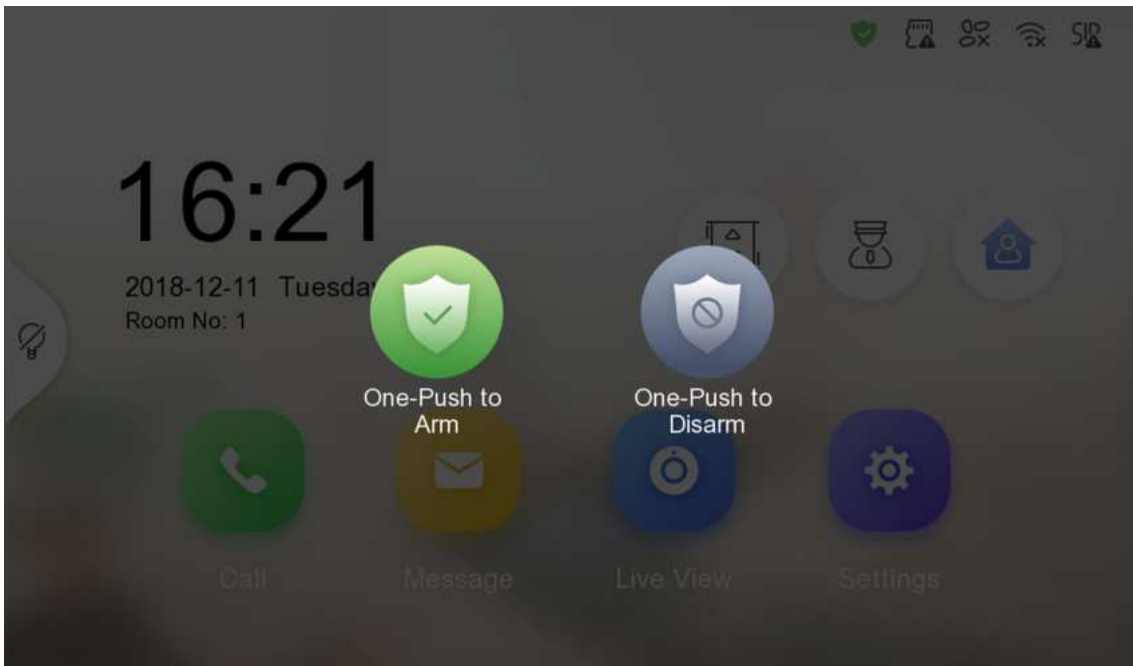

**Figure 8-6 Disarm Room**

2. Enter the arm/disarm password.

---

**Note**

You can set the arm/disarm password in the general settings. For details, see the configuration guide.

3. Tap **OK**.

## 8.1.5 Call Elevator

The indoor station supports calling the elevator.

### Before You Start

Enable call elevator via iVMS-4200 Client Software.

### Steps

1. Tap **Settings** →  → **Shortcut Settings** to enable **Call Elevator**.

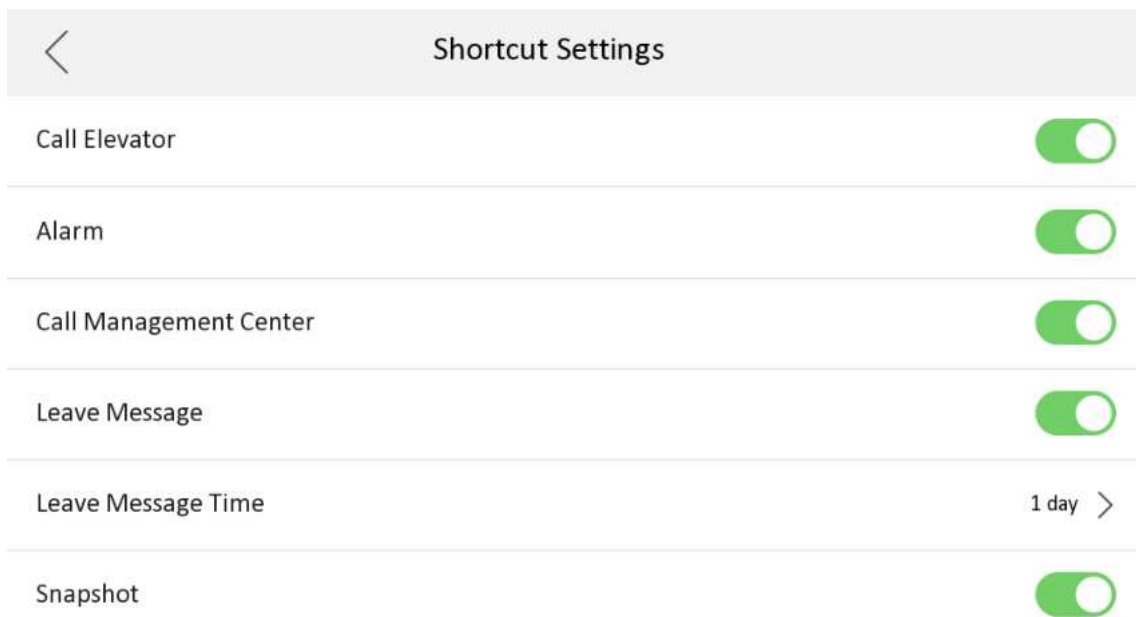



**Figure 8-7 Call Elevator**

2. Tap  on the home page of the indoor station to start calling the elevator.
3. When the device communicates with door station, tap unlock icon to start calling the elevator.

## 8.1.6 Relay Settings

After you set the output parameters and display the relay button on the main page, you can control the relay manually.

### Steps

1. Tap **Settings** →  → **Output Settings** and disable **Hide on Main Page** function.
2. Back to the main page and tap .
3. Select a relay to enable or disable, the control device will start/stop working.

## 8.1.7 Information Management

You can view public notice, visitor message, alarm log and capture log on information management page.

Tap **Message** on the home page to enter the information management page. (Here takes the alarm log page as an example.)



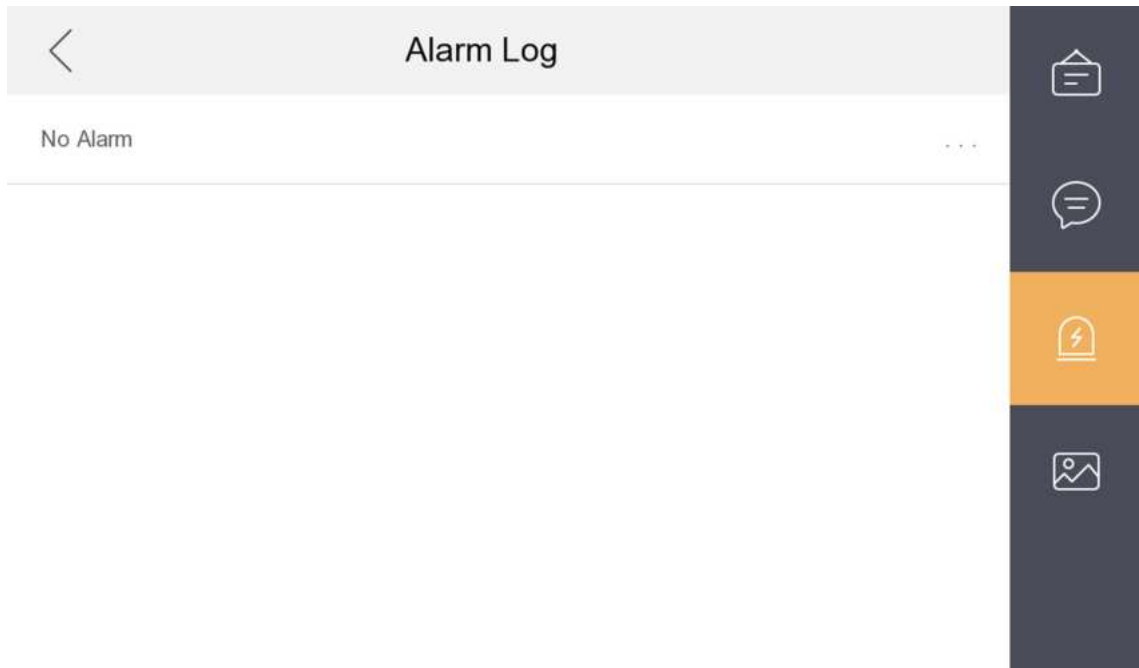

**Figure 8-8 Alarm Logs**

**Delete a Log:** Hold the item, you can delete it.

**Clear Logs:** Hold the item, you can clear all logs.

**See Details:** Hold a alarm log, you can see the alarm details.

---

 **Note**

Indoor extension only supports alarm log and capture log.

---

## Appendix A. Cables

### Cables and Wiring

- When there are multiple cores in one parallel line, only one pair of closed cores are allowed to transmit signal. It is not allowed to use multiple pair of cores in one cable to transmit signal.
- When using parallel lines, it is suggested to use those with shielding layer. If dual core or multiple core parallel lines without shielding layer are routed, stability of signal transmission can be effected. You need to run a test before installation.
- Impedance of cable should not be over suggested value, or distributor cannot transmit enough power to indoor station or door station.
- Strong electricity and weak electricity cannot be wired in the same route, they need to be wired separately and the distance should be more than 0.5 meter.
- All the cables used need to follow the restriction in the following table.

**Table A-1 Wiring Cables**

<b>RVV4 Cable Specification</b>	<b>Transmission Distance (TD)</b>
RVV4 (0.2 mm <sup>2</sup> )	Transmission Distance ≤ 10 m
RVV4 (0.5 mm <sup>2</sup> )	10 m < Transmission Distance ≤ 30 m
RVV4 (0.75 mm <sup>2</sup> )	30 m < Transmission Distance ≤ 50 m
RVV4 (1.5 mm <sup>2</sup> )	50 m < Transmission Distance ≤ 100 m

